

EAN: 3663602419099

# Suhali

**Safety**

- For domestic use only.
- Always use on firm level ground.
- Periodic structural checks of this product should be undertaken, do not use if you have any doubts about its fitness for purpose.
- Do not let children play with this product.
- This product must be set up by a competent adult.
- Keep away from naked flames and direct sources of heat such as patio heaters and barbecues.
- Never stay under this product in thunderstorms.
- Do not hang from the ribs, frame and canopy of this product
- This product is designed for occasional use only. This is not to be used as a permanent structure and must be protected from adverse weather conditions such as high winds, heavy rain and snow. Do not use in such conditions. Dismantle and store safely to prevent any damage occurring.

**At the beginning of the season**

- Check to ensure that all components and fixings of this product are secure, do not use if you have any doubts about its fitness for purpose.

**At the end of the season**

- This product should be stored under cover during prolonged spells of adverse weather (wet or cold) and also during the winter (ideally in a garden shed or garage).
- Always clean and dry thoroughly before storage.

## IMPORTANT, RETAIN FOR FUTURE REFERENCE: READ CAREFULLY.

**Sécurité**

- Produit à usage domestique.
- Positionnez le produit de manière stable sur une surface plane.
- Vérifiez régulièrement ce produit. En cas de doute, ne l'utilisez pas.
- Ne laissez pas les enfants manipuler ce produit.
- Ce produit doit être monté par un adulte.
- Tenez le produit à l'écart des flammes et des sources directes de chaleur telles que les radiateurs d'extérieurs et les barbecues.
- Ne pas rester sous ce produit en cas d'orage.
- Ne les laissez pas se suspendre à la structure.
- Ce produit s'utilise occasionnellement. Il ne doit pas être utilisé comme structure permanente ni lors de mauvaises conditions météorologiques telles que les vents violents, les fortes pluies et la neige. Dans de telles conditions, protégez-le ou démontez-le et rangez-le en sécurité pour éviter tout dommage éventuel.
- A monter soi même.

**En début de saison**

- Vérifiez que tous les composants et fixations de ce produit soient fermement serrés. En cas de doute, ne l'utilisez pas.

**En fin de saison**

- L'hiver ou en cas d'intempéries prolongées, il est recommandé de ranger ce produit dans un garage ou une pièce aérée sans chauffage. Ne le couvrez pas.
- Nettoyez et séchez toujours le produit avant de le ranger.

## IMPORTANT – A CONSERVER POUR DE FUTURS BESOINS DE REFERENCE : A LIRE SOIGNEUSEMENT

**Bezpieczeństwo**

- Meble przeznaczone do użytku prywatnego.
- Zawsze umieszczaj produkt na stabilnej, równej powierzchni.
- Należy okresowo sprawdzać stan produktu. Nie używaj go, jeśli masz jakiegokolwiek wątpliwości.
- Nie pozwól, aby produktem bawiły się dzieci.
- Niniejszy mebel musi zostać zmontowany przez kompetentną osobę dorosłą.
- Trzymaj produkt z dala od płomieni i bezpośrednich źródeł ciepła, takich jak ogrzewacze gazowych i grillów.
- Nigdy nie stój pod niniejszym meblem podczas burzy.
- Nie wieszaj się na poszyciu, jego konstrukcji oraz na ramie tego produktu.
- Niniejszy produkt jest wyłącznie przeznaczony do sezonowego użycia. Nie powinien być używany jako permanentna konstrukcja i musi być chroniony przed niesprzyjającymi warunkami atmosferycznymi, takimi jak silny wiatr lub obfite opady deszczu, śniegu i gradu. Nie używaj w takich warunkach. Rozmontuj i przechowuj w sposób bezpieczny, aby uniknąć uszkodzenia produktu.

**Na początku sezonu**

- Przed użyciem proszę upewnić się, że wszystkie części i elementy montażowe zostały prawidłowo przymocowane. Nie używaj produktu, jeśli masz jakiegokolwiek wątpliwości na temat ich przydatności do użycia.

**Na końcu sezonu**

- Niniejszy produkt powinien być przykryty pokrowcem podczas jego przechowywania, jeśli nie zamierzone jest jego użycie przez dłuższy okres czasu lub podczas złych warunków atmosferycznych (opady deszczu lub niska temperatura otoczenia) oraz podczas zimy (najlepiej przechowywać w schowku lub w garażu).
- Zawsze wyczyść i osusz produkty przed przechowywaniem.

## WAŻNE – NALEŻY DOKŁADNIE PRZECZYTAĆ NINIEJSZE INFORMACJE I ZACHOWAĆ.

**Siguranța**

- Doar pentru folosire acasă.
- Folosiți produsul întotdeauna numai pe teren ferm și drept.
- Periodic, trebuie făcute verificări ale structurii acestui produs, nu o folosiți dacă aveți îndoieli asupra capacității ei, de exemplu.
- Nu permiteți copiilor să se joace cu acest produs.
- Acest produs trebuie asamblat de un adult responsabil.
- Țineți departe de flăcări acoperite și surse de căldură directe, cum ar fi încălzitoare de curte interioară și grătare.
- Nu stați niciodată sub acest produs în timpul unei furtuni cu tunete.
- Nu vă agățați de arcurile, cadrul și acoperișul acestui produs.

- Acest produs este proiectat doar pentru folosirea ocazională. Acesta nu trebuie folosit ca o structură permanentă și trebuie protejat de condițiile nefavorabile de vreme, cum ar fi vânt puternic, ploaie puternică și zăpadă. Nu-l folosiți în astfel de condiții. Demontați-l și depozitați-l cu grijă pentru a preveni apariția oricărei deteriorări.

**La începutul sezonului**

- Verificați pentru a vă asigura că toate componentele și dispozitivele de prindere ale acestui produs sunt sigure și nu îl folosiți dacă aveți îndoieli asupra capacității lui, de exemplu.

**La sfârșitul sezonului**

- Acest produs trebuie depozitată acoperită în timpul perioadelor lungi de vreme nefavorabilă (umezeală sau frig) și de asemenea în timpul iernii (ideal într-o baracă de grădină sau în garaj).
- Curățați și uscați bine înainte de depozitare.

# IMPORTANT – PĂSTRAȚI ACESTE INFORMAȚII PENTRU REFERINȚE VIITOARE: CITIȚI CU ATENȚIE.

**Seguridad**

- Para uso exclusivo doméstico.
- Siempre utilice el producto sobre el suelo, en una superficie plana.
- Se deben llevar a cabo revisiones periódicas de la estructura del producto, no lo utilice si tiene alguna duda sobre su estado, o su uso.
- No permita que los niños jueguen con este producto.
- Estos muebles debe montarlos un adulto competente.
- Mantenga el producto alejado de llamas y fuentes de calor directas como estufas calefactoras para exteriores y barbacoas.
- Nunca permanezca bajo este producto durante una tormenta.
- No colgar de las varillas, del marco ni de la cubierta de este producto.
- Este producto ha sido diseñado para un uso exclusivamente ocasional. No debe utilizarse como estructura permanente y debe protegerse de condiciones climáticas adversas como viento fuerte, lluvia torrencial y nieve. No lo utilice en esas condiciones. Desmónte y guárdelo en un sitio seguro para evitar daños.

**Al principio de la temporada**

- Revise el producto para asegurarse de que todos los componentes y accesorios están bien fijados y sujetos, no lo utilice si tiene alguna duda sobre el estado o el uso del producto.

**Al final de la temporada**

- Este producto debe guardarse bajo cubierto durante largos periodos de mal tiempo o condiciones meteorológicas adversas (de frío o lluvia) y también durante el invierno (preferentemente en un garaje o trastero).
- Siempre limpie y seque a fondo el producto antes de almacenarlo.

# IMPORTANTE – GUARDE ESTA INFORMACIÓN PARA FUTURAS CONSULTAS: LEA ATENTAMENTE.

**Segurança**

- ✓ Exclusivo para uso doméstico.
- ✓ Utilize sempre este produto no chão, sobre uma superfície plana.
- ✓ Devem ser levadas a cabo revisões periódicas da estrutura do produto, não o utilize se tiver alguma dúvida sobre o seu estado, ou o seu uso.
- ✓ Não permita que as crianças brinquem com este produto.
- ✓ Este produto devem ser montados por um adulto competente.
- ✓ Mantenha o produto afastado de chamas e fontes de calor diretas como aquecedores para exterior e churrasqueiras.
- ✓ Nunca permaneça debaixo do produto durante uma tempestade.
- ✓ Não pendurar nas hastes, na armação nem na cobertura do produto.
- ✓ Este produto foi desenhado para um uso exclusivamente ocasional. Não deve ser utilizado como estrutura permanente e deve proteger-se de condições climáticas adversas como vento forte, chuva torrencial e neve. Não utilizar nessas condições. Desmonte e guarde num local seguro para evitar danos.

**No princípio da temporada**

- ✓ Faça uma revisão do produto para garantir que todos os componentes e acessórios estão bem fixos e seguros, não utilize se tiver alguma dúvida sobre o estado ou a utilização deste produto.

**No final da temporada**

- ✓ Este produto deve ser guardado num local coberto durante longos períodos de mau tempo ou condições meteorológicas adversas (de frio ou chuva) e também durante o inverno (preferivelmente numa garagem ou arrecadação).
- ✓ Limpe e seque sempre a fundo o produto antes de guardá-lo.

# IMPORTANTE – CONSERVE ESTE MANUAL PARA FUTURAS CONSULTAS: LEIA ATENTAMENTE.

**Güvenlik**

- ✓ Sadece ev kullanımı içindir.
- ✓ Her zaman sağlam bir zemin üzerinde kullanın.
- ✓ Bu ürünün periyodik yapısal kontrolleri gerçekleştirilmeli, amaca uygun kullanımı ile ilgili şüpheler durumunda kullanılmamalıdır.
- ✓ Çocukların bu mobilya ile oynamalarına izin vermeyin.
- ✓ Bu mobilya uzman bir yetişkin tarafından kurulmalıdır.
- ✓ Açık alevler ile ev tipi ısıtıcı ve barbekü gibi doğrudan ısı kaynaklarından uzak tutun.
- ✓ Gök gürültüsü sağanak yağışlarda bu ürünün altında asla durmayın.
- ✓ Hiçbir şekilde ürünün iskeleti, güneşliği ve askılarına asılmayınız.
- ✓ Bu ürün sadece geçici kullanım için tasarlanmıştır. Kalıcı bir yapı olarak kullanılmamalı ve kuvvetli rüzgar, şiddetli yağmur, kar gibi elverişsiz hava koşullarından korunmalıdır. Bu koşullar altında kullanmayın. Herhangi bir hasara meydan vermemek için ürünü demonte edin ve güvenli bir şekilde saklayın.

**Sezon başlarken**

- ✓ Bu ürünün tüm parçaları ve donanımlarının güvenli olduğundan emin olun, amaca uygun kullanımı ile ilgili şüpheler durumunda kullanmayın.

**Sezon biterken**

- ✓ Bu ürün, uzun süreli kötü hava şartlarında (yağmur veya soğuk) ve kış boyunca üzerine örtü örtülerek muhafaza edilmelidir (ideal olarak bahçedeki bir baraka veya garajda).
- ✓ Muhafaza etmeden önce daima temizleyin ve iyice kurulayın.

BU ÜRÜNÜN BAĞLANTI VEYA MONTAJI TÜKETİCİYE AİTTİR. MONTAJ HİZMETİ VEYA BU AD ALTINDA ALINAN MONTAJ BEDELİ ÜRÜNÜN SATIŞ BEDELİNE DAHİL DEĞİLDİR.

# ÖNEMLİ – BU BİLGİLERİ DAHA SONRA KULLANMAK ÜZERE SAKLAYIN: DİKKATLE OKUYUN.

---

## Addresses

---

**Manufacturer • Fabricant • Producent • Producător •**

**Fabricante:**

**UK Manufacturer:**

**1 Paddington Square, London, W2 1GG,**

United Kingdom

**EU Manufacturer:**

Kingfisher International Products B.V.

Rapenburgerstraat 175E

1011 VM Amsterdam

The Netherlands

[www.kingfisher.com/products](http://www.kingfisher.com/products)

**EN**

[www.diy.com](http://www.diy.com)

[www.screwfix.com](http://www.screwfix.com)

[www.screwfix.ie](http://www.screwfix.ie)

**To view instruction manuals online,**

**visit [www.kingfisher.com/products](http://www.kingfisher.com/products)**

**FR**

[www.castorama.fr](http://www.castorama.fr)

[www.bricodepot.fr](http://www.bricodepot.fr)

**Pour consulter les manuels d'instructions**

**en ligne, rendez-vous sur le site**

**[www.kingfisher.com/products](http://www.kingfisher.com/products)**

**PL**

[www.castorama.pl](http://www.castorama.pl)

**Aby zapoznać się z instrukcją obsługi online,**

**odwiedź stronę [www.kingfisher.com/products](http://www.kingfisher.com/products)**

**RO** [www.bricodepot.ro](http://www.bricodepot.ro)

**Pentru a consulta manualele de instrucțiuni online,**  
**vizitați [www.kingfisher.com/products](http://www.kingfisher.com/products)**

**ES**

[www.bricodepot.es](http://www.bricodepot.es)

**Para consultar los manuales de instrucciones**

**en línea, visite [www.kingfisher.com/products](http://www.kingfisher.com/products)**

**PT**

[www.bricodepot.pt](http://www.bricodepot.pt)

**Para consultar manuais de instruções online,**

**visite [www.kingfisher.com/products](http://www.kingfisher.com/products)**

**TR**

**İthalatçı Firma:**

**KOÇTAŞ YAPI MARKETLERİ TİC. A.Ş.**

**Taşdelen Mah. Sırrı Çelik Bulvarı No:5**

**34788 Taşdelen/Çekmeköy/İSTANBUL**

**Tel: +90 216 4300300**

**Faks: +90 216 4844313**

**[www.koctas.com.tr](http://www.koctas.com.tr)**

**Kullanım kılavuzuna internet üzerinden ulaşmak**

**için [www.kingfisher.com/products](http://www.kingfisher.com/products) adresini**

**ziyaret edin**

**Yetkili servis istasyonları ve yedek parça temini için**

**aşağıda yer alan Koçtaş Müşteri Hattı ve Koçtaş Genel**

**Müdürlük irtibat bilgilerinden faydalanınız.**

**KOÇTAŞ MÜŞTERİ HİZMETLERİ**

**0850 209 50 50**



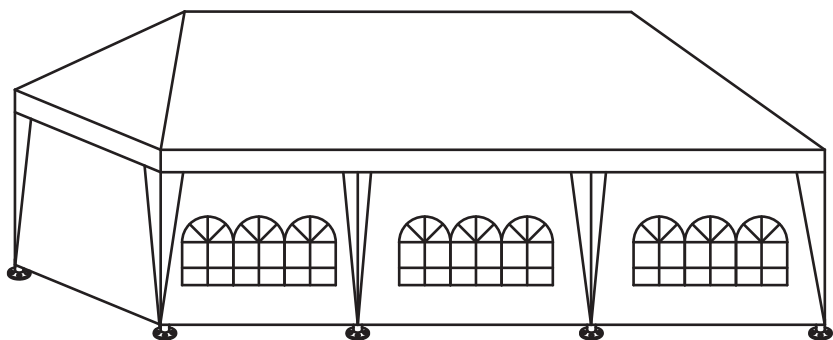

EAN: 3663602419099

# Suhali



**EN** IMPORTANT - Please read carefully the separate safety guide before use.

**FR** IMPORTANT - Lire attentivement le guide de sécurité séparé avant utilisation.

**PL** WAŻNE - Przed użyciem proszę dokładnie zapoznać się z instrukcją bezpieczeństwa.

**RO** IMPORTANT - Vă rugăm să citiți cu atenție ghidul de siguranță separat înainte de utilizare.

**ES** IMPORTANTE - Lea atentamente la guía de seguridad separado antes de utilizar.

**PT** IMPORTANTE - Leia atentamente o guia de segurança separado antes de usar.

**TR** ÖNEMLİ - Kullanmadan önce emniyet kurallarını lütfen dikkatle okuyun.

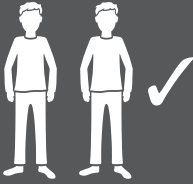

[01] x 12  
(Ø24 X 1115 mm)

[02] x 32  
(Ø24 X 1050 mm)

[03] x 10  
(Ø24 X 900 mm)

[04] x 8  
(Ø32 X 1120 mm)

[05] x 8  
(Ø32 X 1120 mm)

[06] x 4

[07] x 4

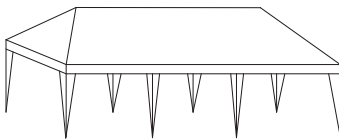

[08] x 1



[09] x 2



[10] x 1



[11] x 8

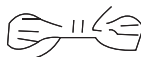

[12] x 8



[13] x 16



[14] x 6



[15] x 2





EN Assembly  
RO Asamblare  
TR Kurulum

FR Assemblage  
ES Montaje

PL Montaż  
PT Montagem

# 01



[02] x 8



[06] x 4

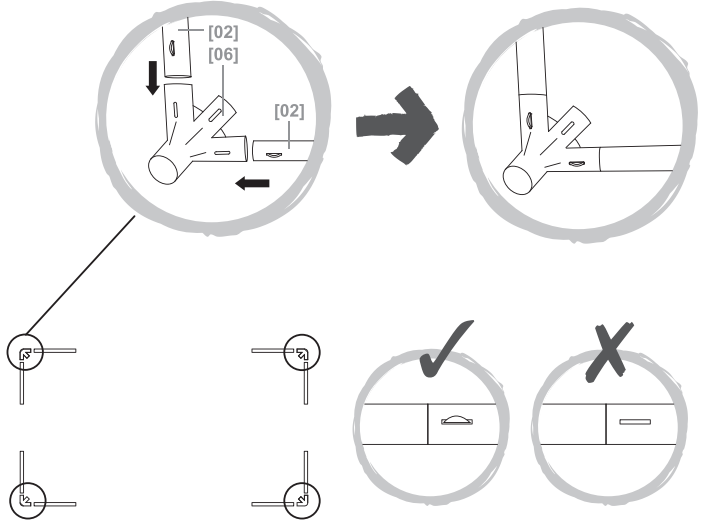

# 02



[02] x 8

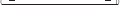

[03] x 8

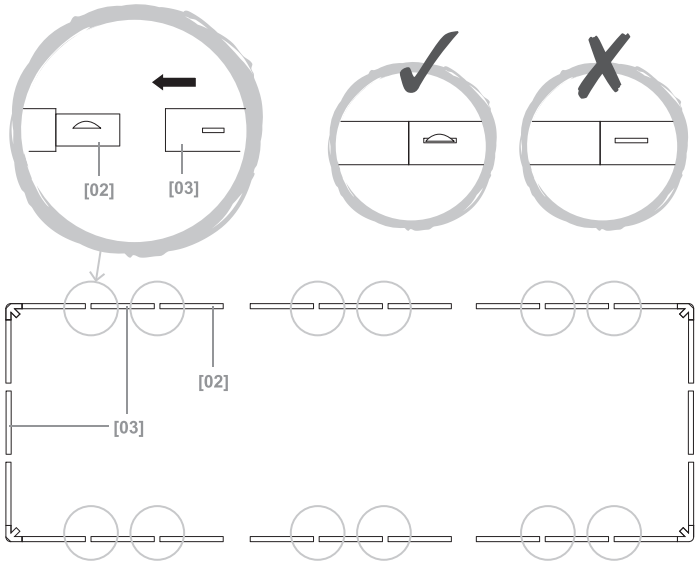

# 03



[07] x 4

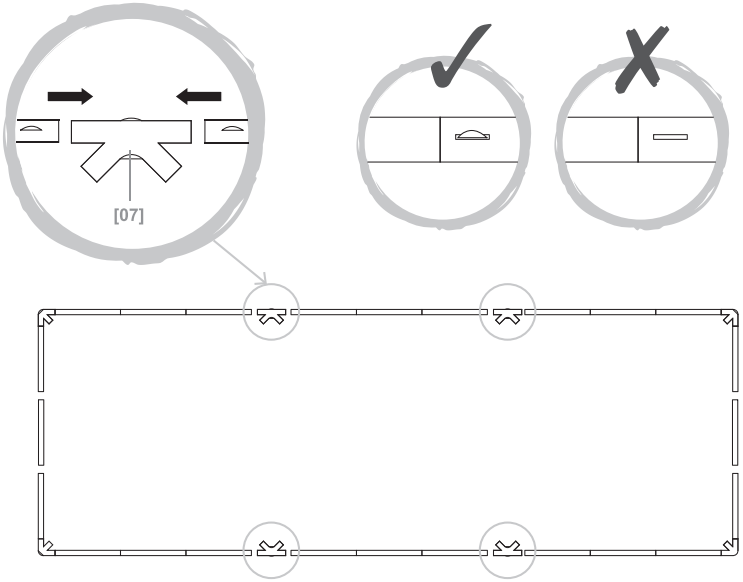

# 04



[02] x 4

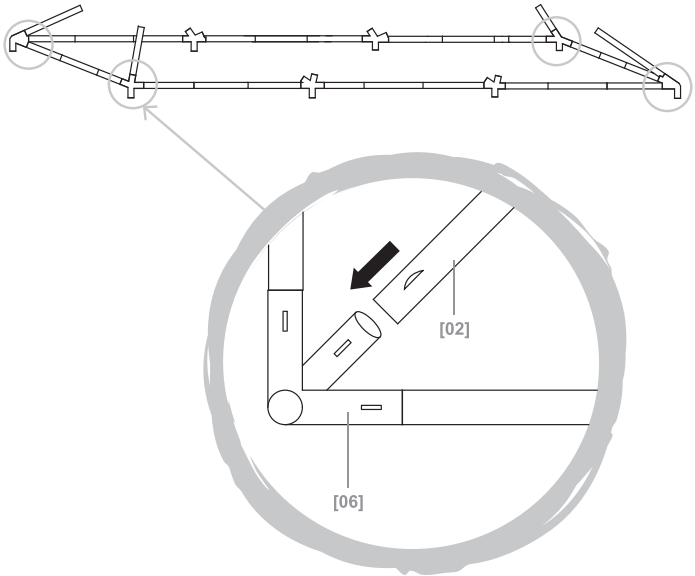

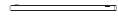
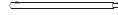
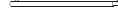

# 05

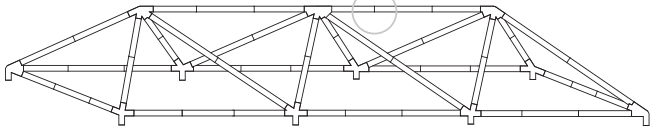
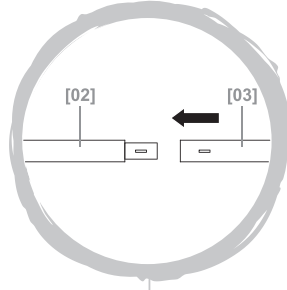
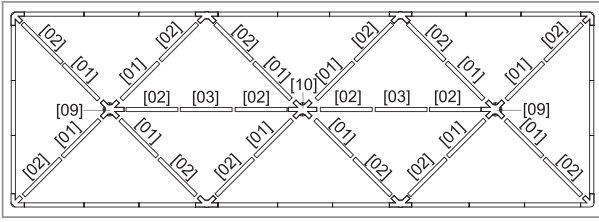
-  [01] x 12
-  [02] x 12
-  [03] x 2



# 06

-  [09] x 2
-  [10] x 1

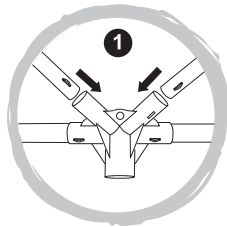
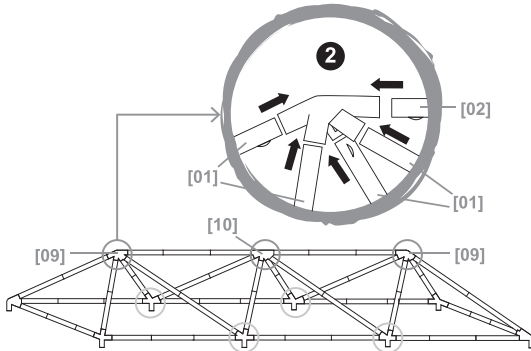

07



[08] x 1

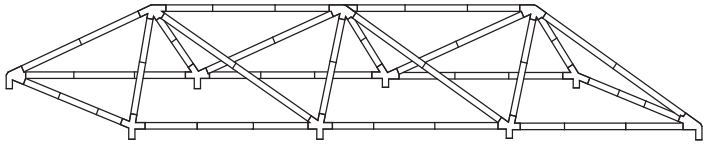
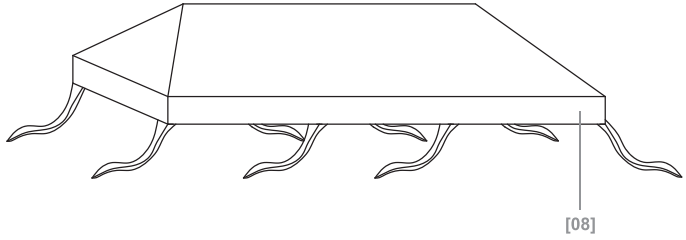

# 08

- [04] x 8
- [05] x 8
- [11] x 8
- [13] x 8

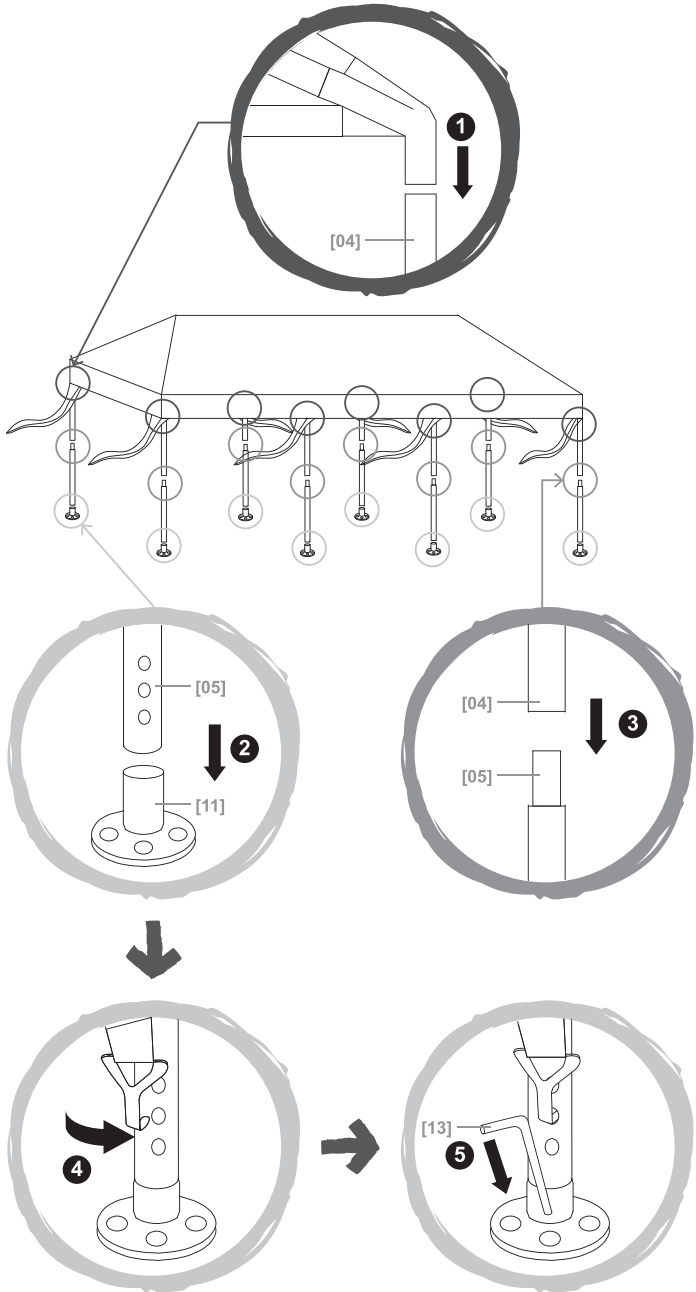

09



[12] x 8



[13] x 8

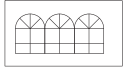

[14] x 6



[15] x 2

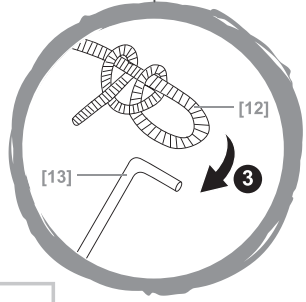
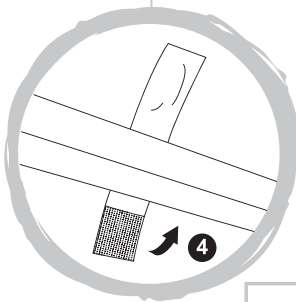
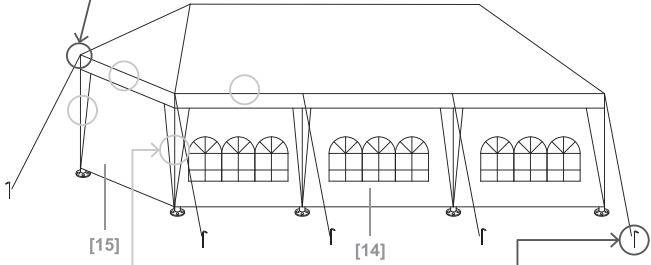
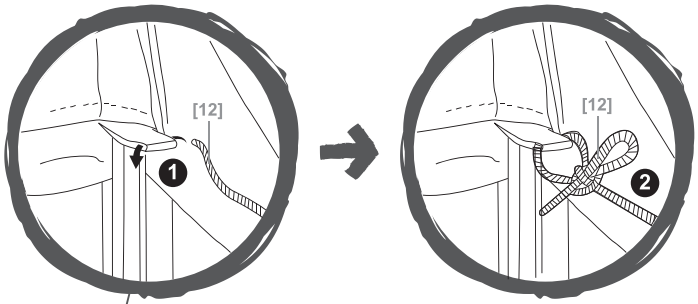

x 8

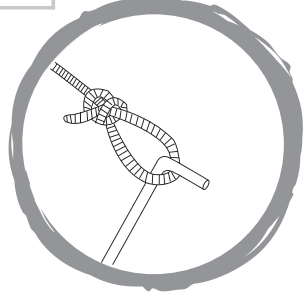
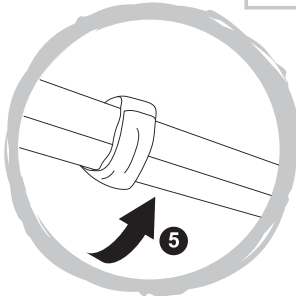



EN Care

RO Îngrijire

TR Bakım

FR Entretien

ES Advertancia

PL Pielęgnacja

PT Aviso

