

3663602991649

# Major



**EN** **IMPORTANT** - Please read carefully the separate safety guide before use.

**FR** **IMPORTANT** - Lire attentivement le guide de sécurité séparé avant utilisation.

**PL** **WAŻNE** - Przed użyciem proszę dokładnie zapoznać się z instrukcją bezpieczeństwa.

**DE** **WICHTIG** - Bitte lesen sie die separaten sicherheitsanweisungen vor gebrauch.

**RU** **ВАЖНО** - Пожалуйста, внимательно прочитайте отдельное руководство по технике безопасности перед использованием.

**RO** **IMPORTANT** - Va rugăm să citiți cu atenție ghidul de siguranță separat înainte de utilizare.

**ES** **IMPORTANTE** - Lea atentamente la guía de seguridad separado antes de utilizar.

**PT** **IMPORTANTE** - Leia atentamente o guia de segurança separado antes de usar.

**TR** **ÖNEMLİ** - Kullanmadan önce emniyet kurallarını lütfen dikkatle okuyun.

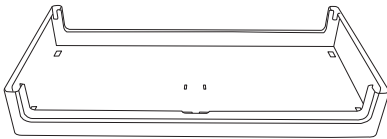
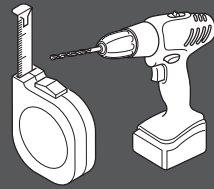
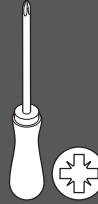
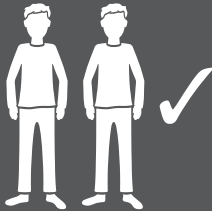

[A1] x 1



[A7] x 1



[A2] x 2



[A3] x 2



[A4] x 1

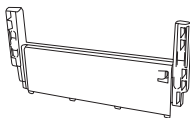

[A5] x 1

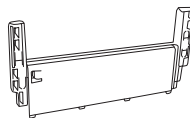

[A6] x 1



x 2

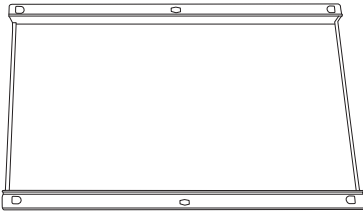

[B1] x 4

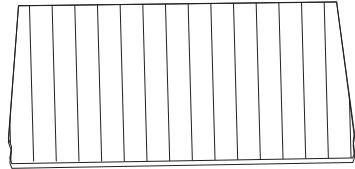

x 2

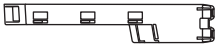

[C10] x 1



[C11] x 1

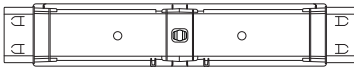

[B3] x 1

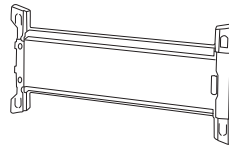

[B4] x 2

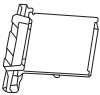

[B2] x 2



[4,2X22] x 20



x 4

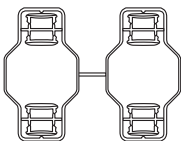

x 1

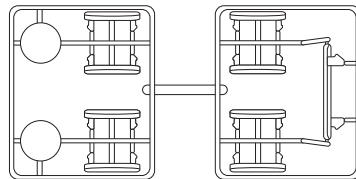



[C2] x 1



[C7] x 2



[C3] x 1



[C8] x 2

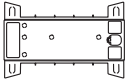

[D3] x 1

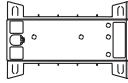

[D4] x 1

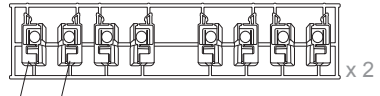

[E3] [E2] x 2



[D1] x 2



[D2] x 2

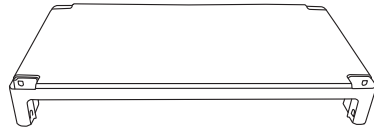

[C1] x 1

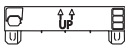

[D5] x 1

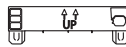

[D7] x 1

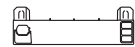

[D6] x 1

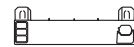

[D8] x 1



[C4] x 1



[C5] x 1



[D24] x 1



[D25] x 1

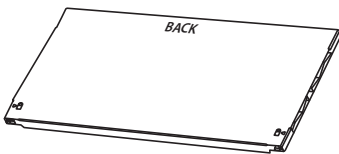

[E1] x 4



x 6



x 8



EN Assembly    FR Assemblage    PL Montaż    DE Montage    RU Сборка  
RO Asamblare    ES Montaje    PT Montagem    TR Kurulum

01



[A2] x 1



[A3] x 1

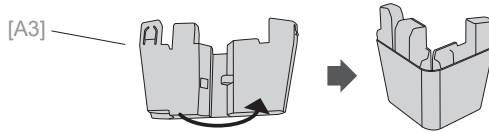
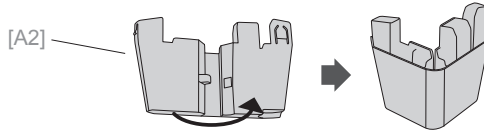

x 2

02



[A1] x 1

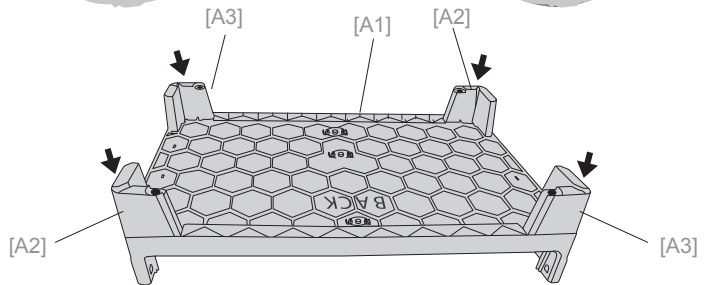
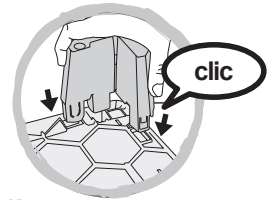
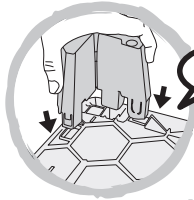

03



[A4] x 1

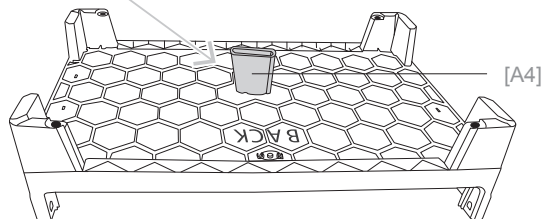
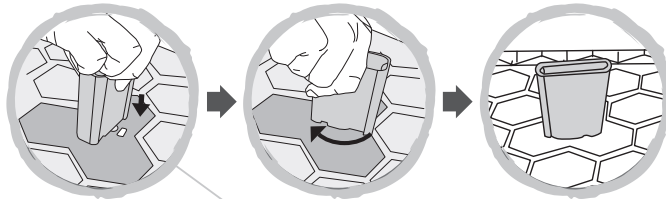

04



x 2

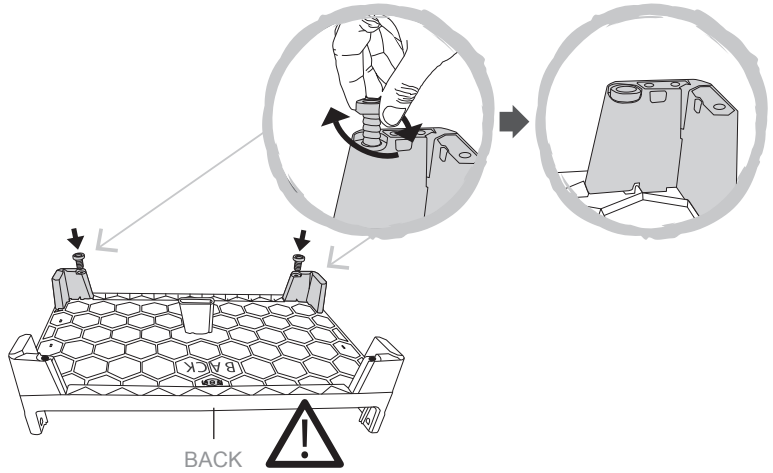

05

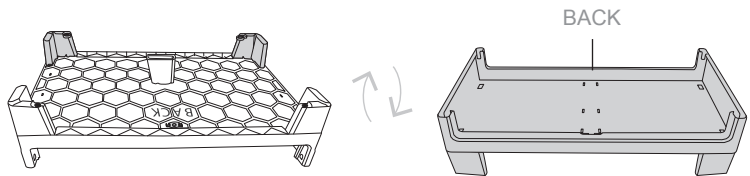

06



[A5] x 1

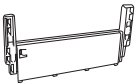

[A6] x 1



[A7] x 1

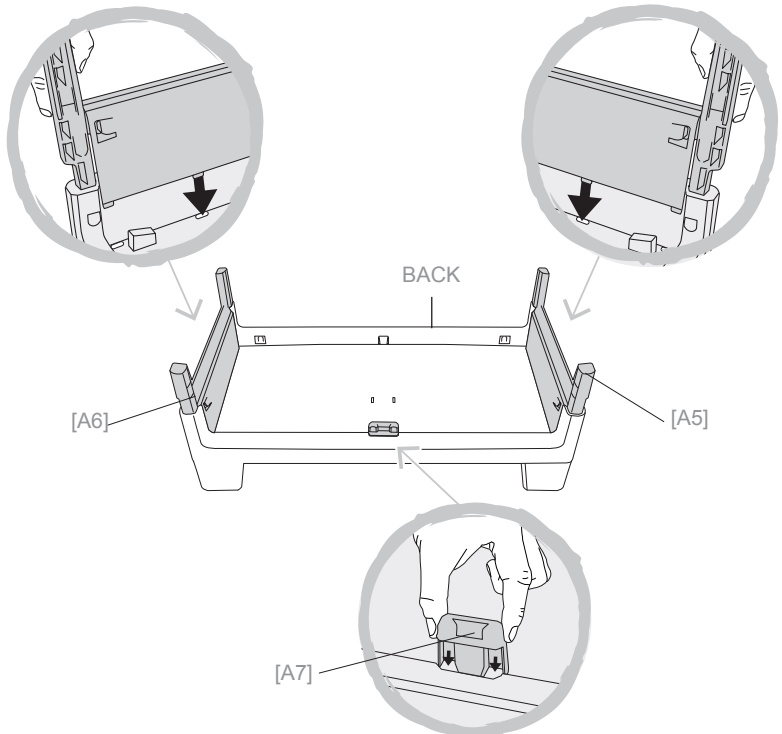

07

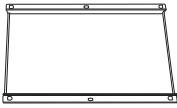

[B1] x 2

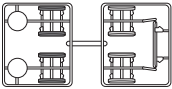

x 1

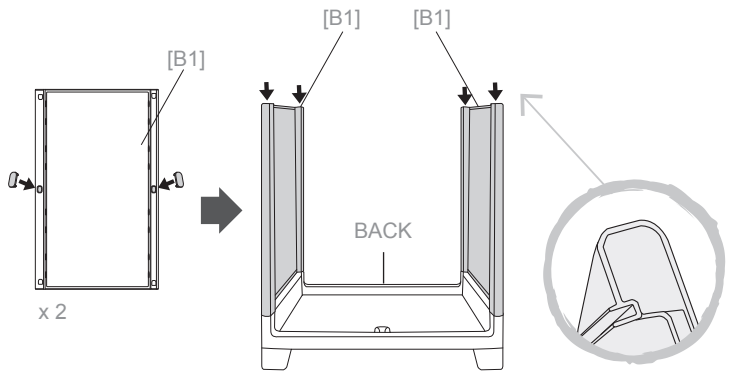

08



x 1

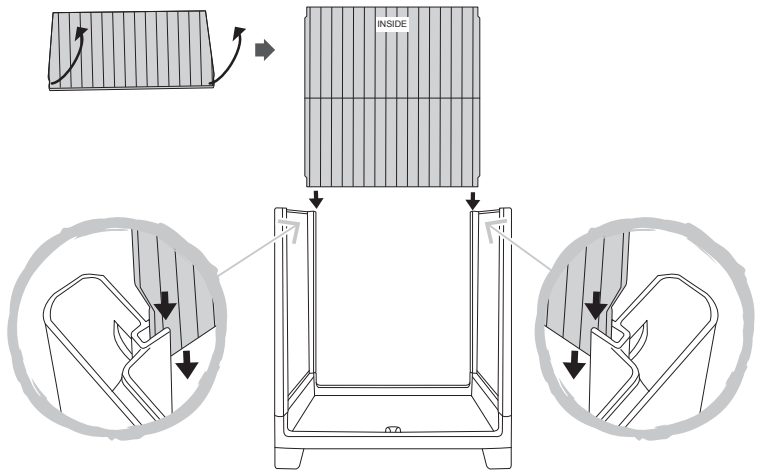

09



[B3] x 1

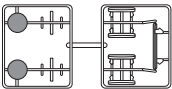

x 1

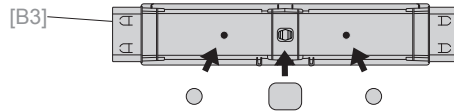

10



# 11



[B2] x 2

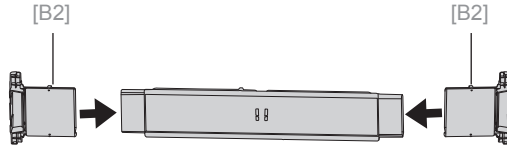

# 12



[B4] x 2

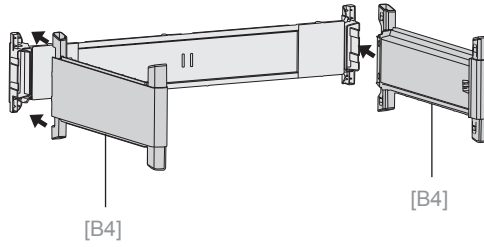

# 13

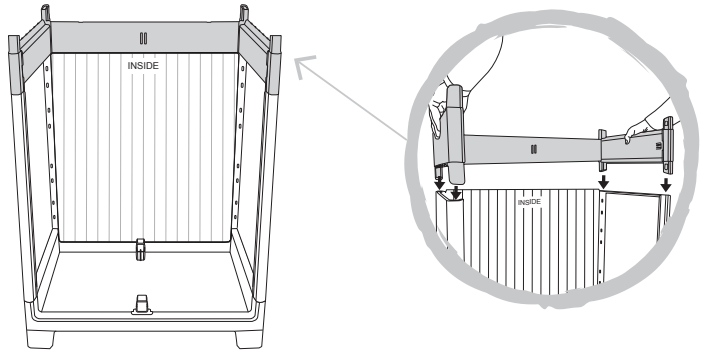

# 14

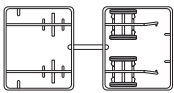

x 1

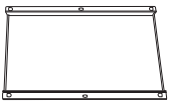

[B1] x 2

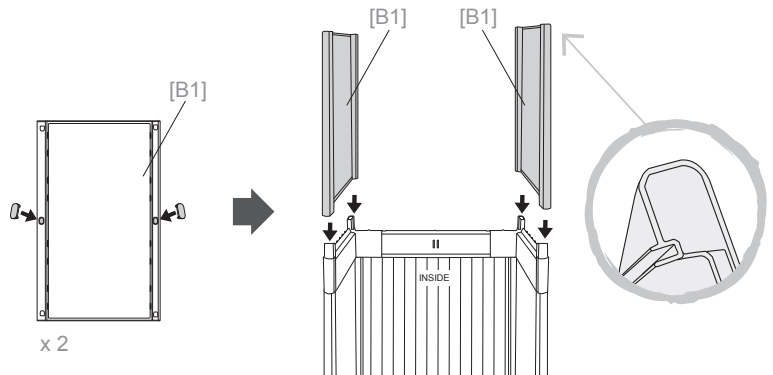



# 15



x 1

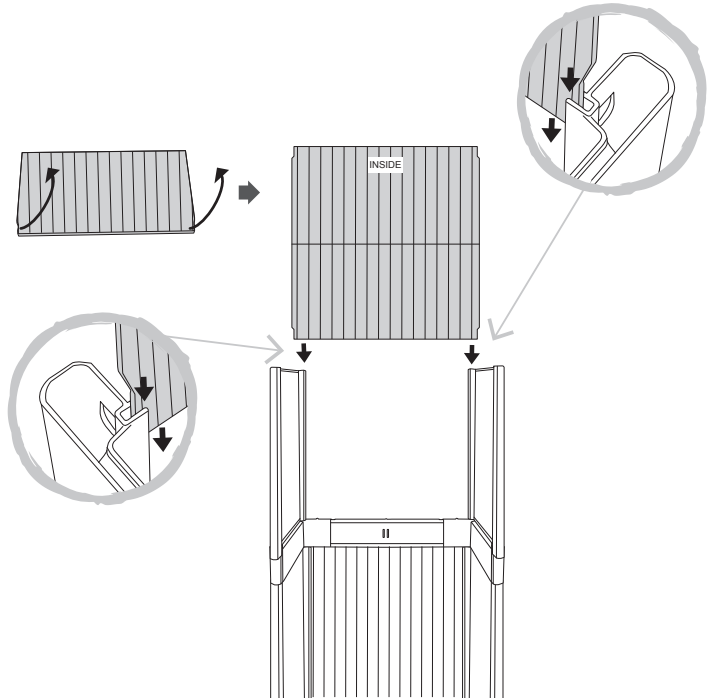

# 16

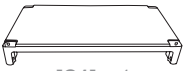

[C1] x 1



[C2] x 1



[C3] x 1



[C4] x 1



[C5] x 1

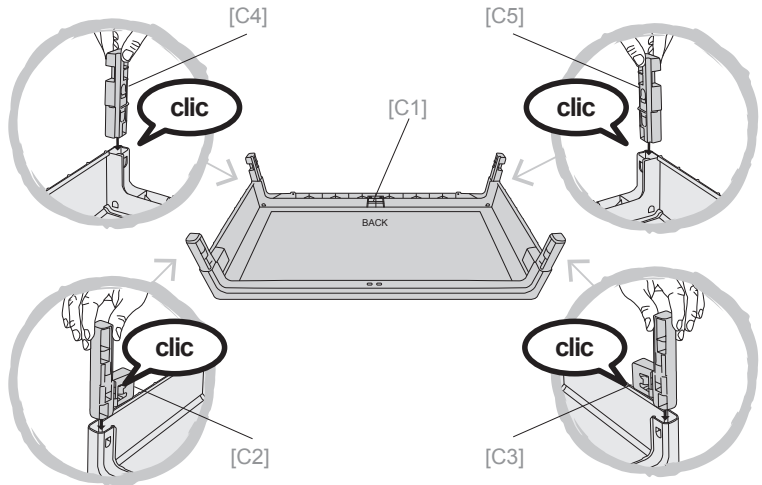

17

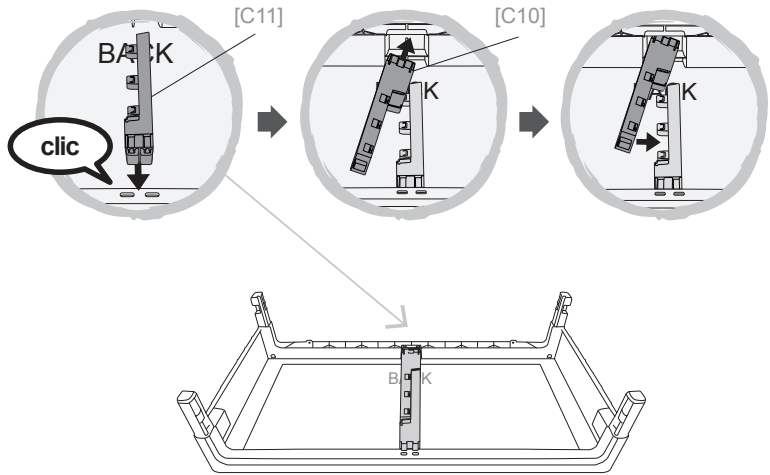

[C10] x 1



[C11] x 1

18

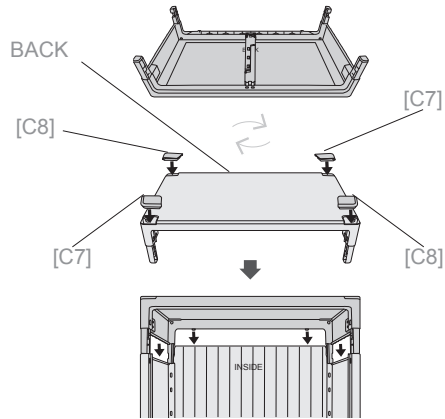

[C7] x 2



[C8] x 2

19

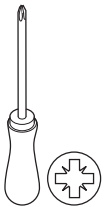
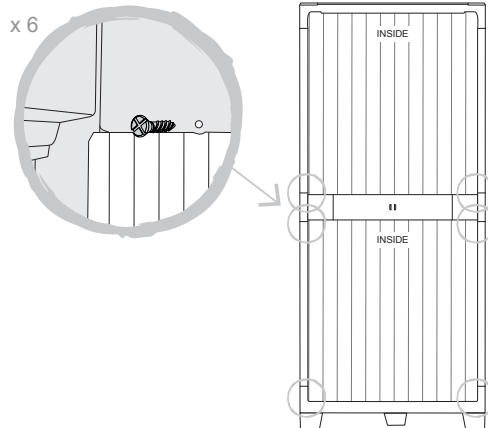

[4,2X22] x 6

# 20

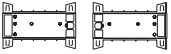

[D3] x 1 [D4] x 1



[D5] x 1 [D7] x 1



[D6] x 1 [D8] x 1



x 6



x 3



x 3

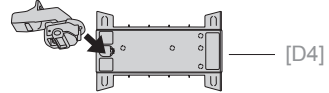
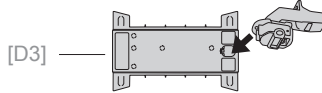
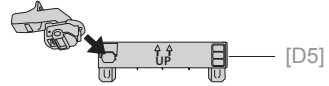
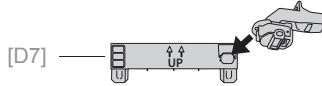

# 21



[D1] x 2



[D2] x 2

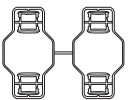

x 1

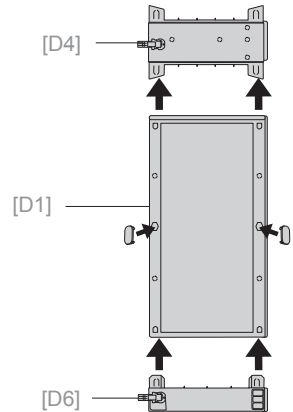
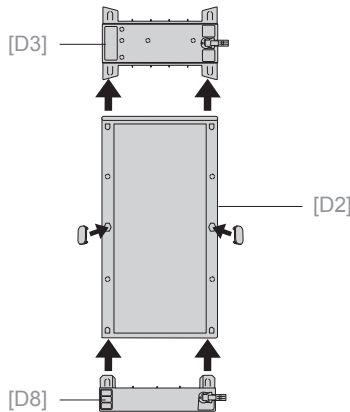
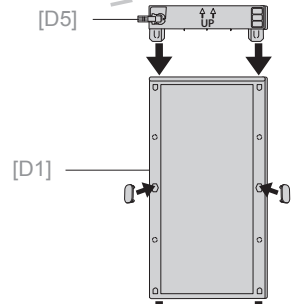
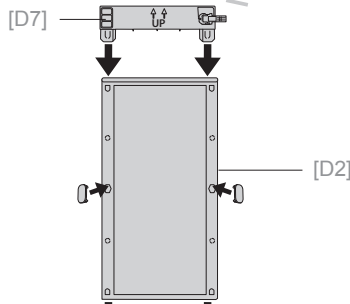

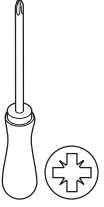

[4,2X22] x 6

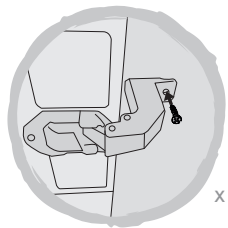
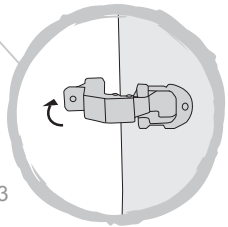
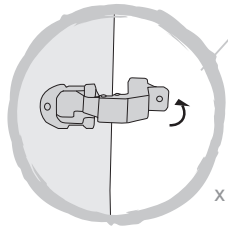
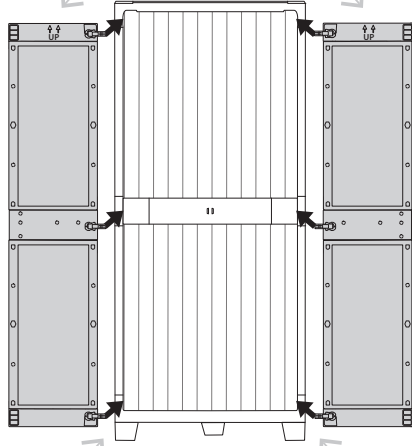
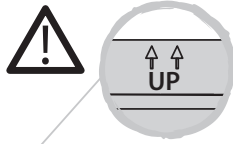

23



[D24] x 1



[D25] x 1

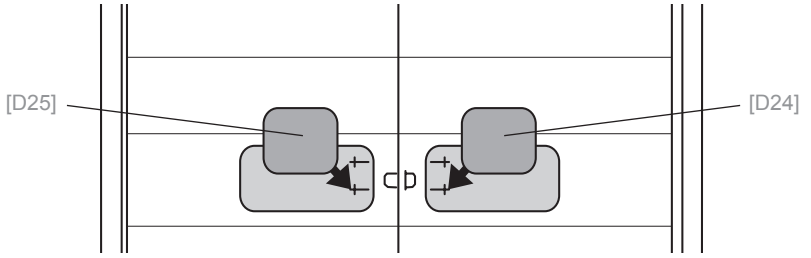

24

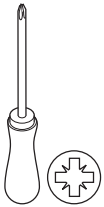

[4,2X22] x 8



[D24] x 1



[D25] x 1

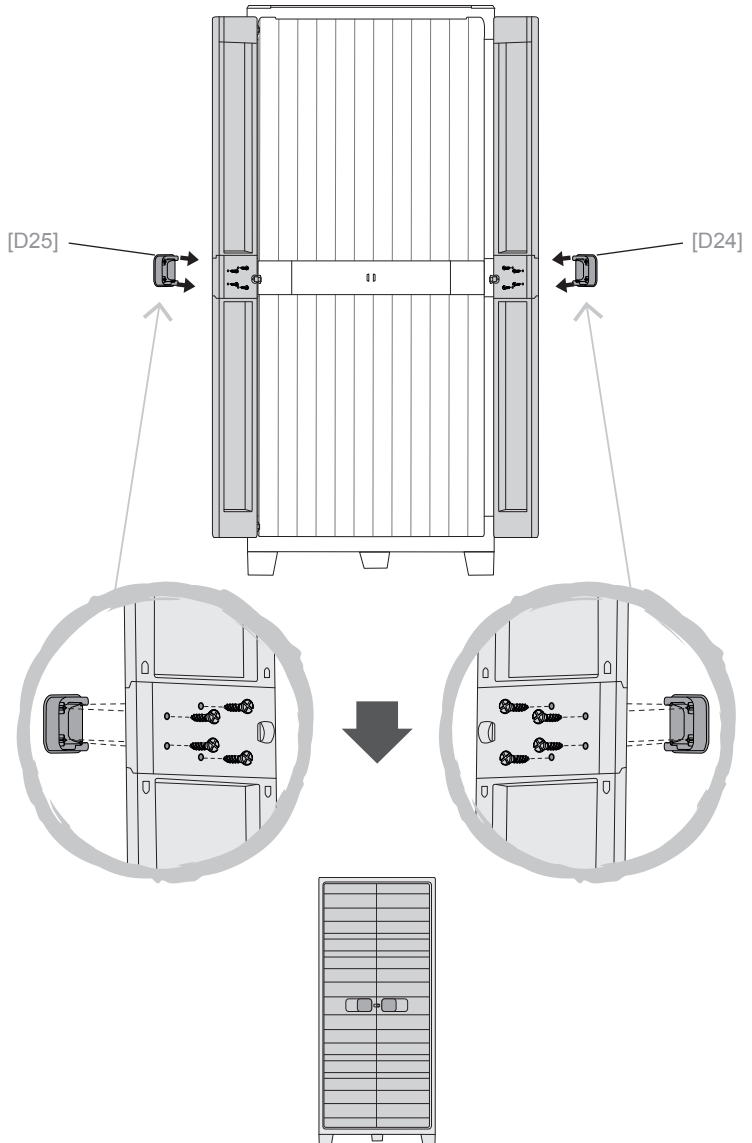

# 25

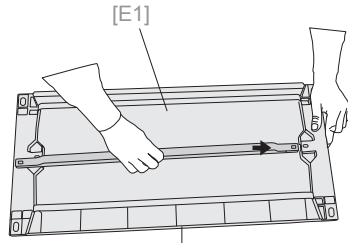
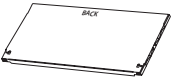

BACK

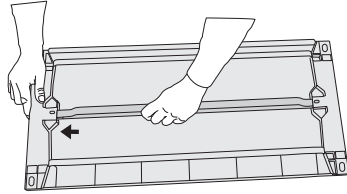

# 26

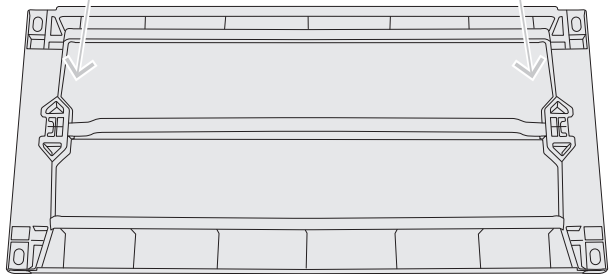
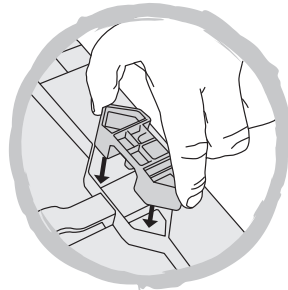
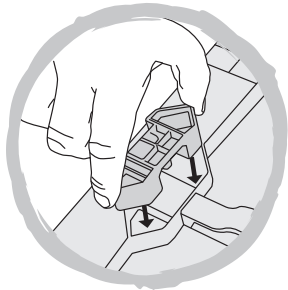

x 4



[E2] x 8

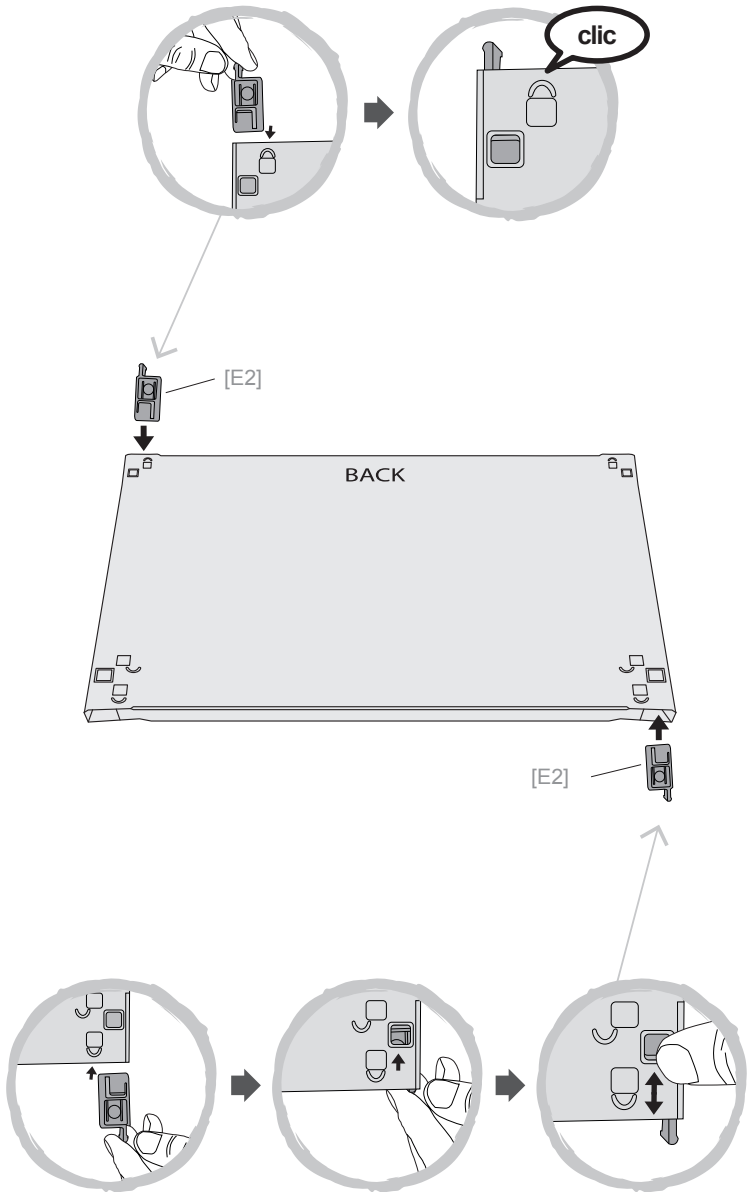



[E3] x 8

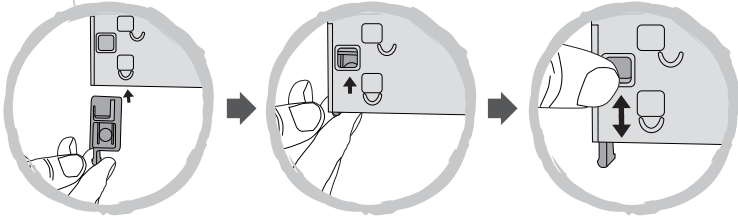
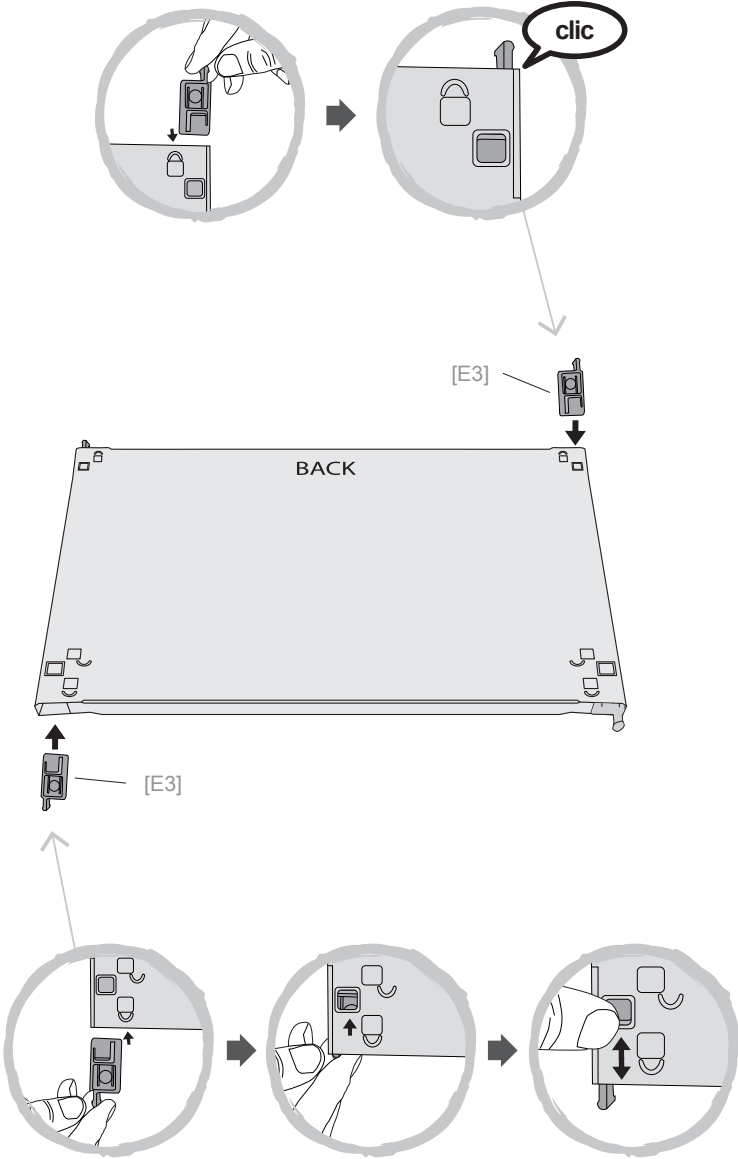



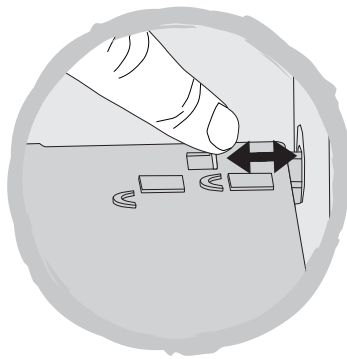
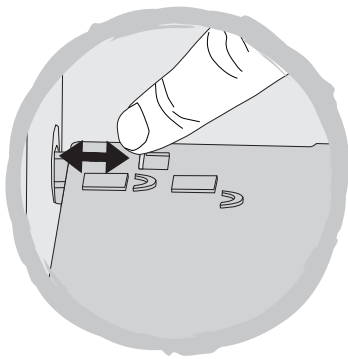
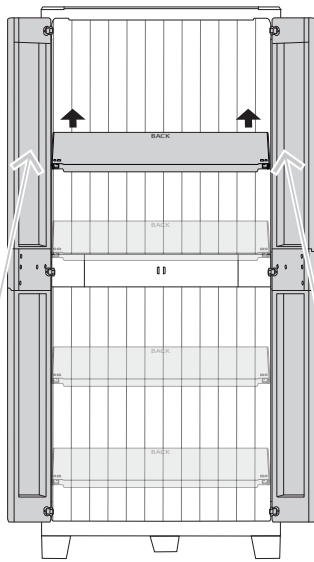

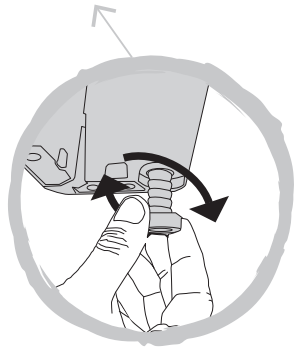
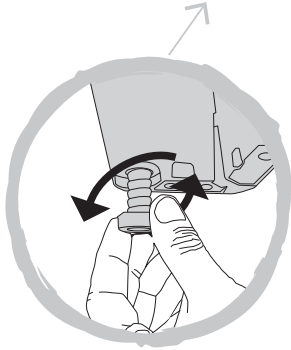
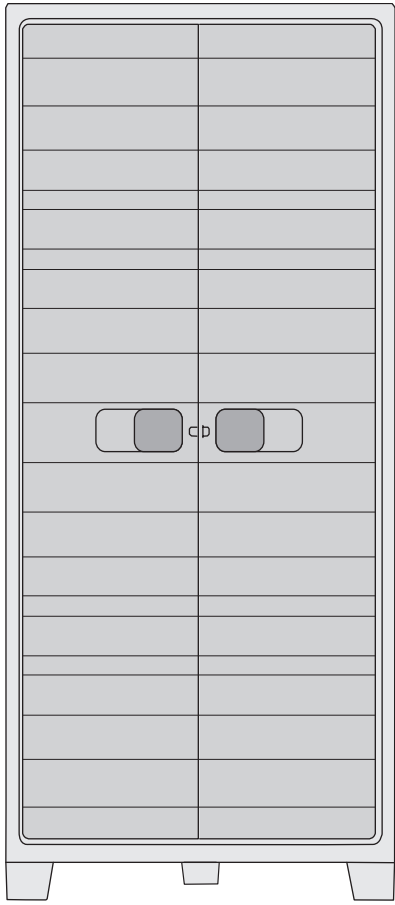

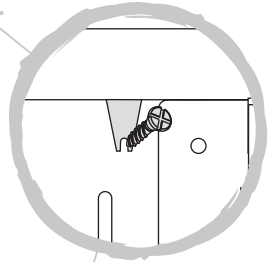
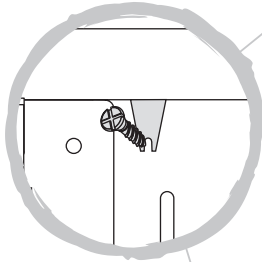
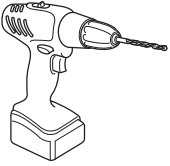

- EN Not included
- FR Non inclus
- PL Nie zawiera
- RO Nu este inclus
- ES No incluido
- PT Não incluída
- TR Dahil değildir

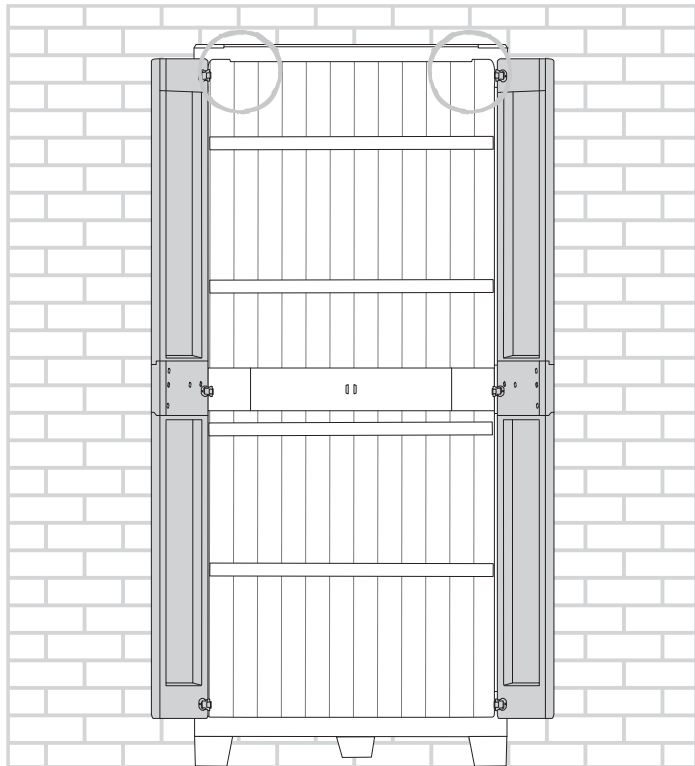

Kingfisher International Products Limited,  
3 Sheldon Square, London, W2 6PX,  
United Kingdom

EN

**Distributor:**

B&Q plc, Chandlers Ford, Hants, SO53 3LE  
United Kingdom [www.diy.com](http://www.diy.com)  
SFD Limited, Trade House, Mead Avenue,  
Yeovil, BA22 8RT, United Kingdom

**Manufacturer, Fabricant, Hersteller,  
Producator, Fabricante:**

Kingfisher International Products Limited,  
3 Sheldon Square, London, W2 6PX,  
United Kingdom

FR

**Distributeur:**

Castorama France C.S. 50101 Templemars  
59637 Wattignies CEDEX [www.castorama.fr](http://www.castorama.fr)

BRICO DÉPÔT 30-32 rue de la Tourelle  
91310 Longpont-sur-Orge France  
[www.bricodepot.com](http://www.bricodepot.com)

PL

**Dystrybutor:**

Castorama Polska Sp. z o.o.  
ul. Krakowiaków 78, 02-255 Warszawa  
[www.castorama.pl](http://www.castorama.pl)

DE

Screwfix Direct Limited Mühlheimer  
Straße 15363075 Offenbach/Main  
[www.screwfix.de](http://www.screwfix.de)

RUS

**Импортер:**

ООО "Касторама РУС" Дербеневская наб.,  
дом 7, стр 8 Россия, Москва, 115114  
[www.castorama.ru](http://www.castorama.ru)

**Изготовитель для России:**

ABM Italia S.p.A.  
Адрес  
Via Taliercio, 2 - 31024 Omelle (TV)

RO

**Distribuito:**

SC Bricostore România SA Calea Giulești  
1-3, Sector 6, București România  
[www.bricodepot.ro](http://www.bricodepot.ro)

ES

**Distribuidor:**

Euro Depot España, S.A.U. c/ La Selva,  
10 - Edificio Inblau A 1a Planta 08820-El  
Prat de Llobregat [www.bricodepot.es](http://www.bricodepot.es)

PT

**Distribuidor:**

Brico Depot Portugal SA Rua Castilho,  
5 - 1 esquerdo, sala 13 1250-066 Lisboa  
[www.bricodepot.pt](http://www.bricodepot.pt)

TR

**İthalatçı Firma:**

KOÇTAŞ YAPI MARKETLERİ TİC. A.Ş.  
Taşdelen Mah. Sırrı Çelik Bulvarı No:5  
34788 Taşdelen/Çekmeköy/İSTANBUL  
Tel: +90 216 4300300  
Faks: +90 216 4844313  
[www.koctas.com.tr](http://www.koctas.com.tr)

Yetkili servis istasyonları ve yedek parça  
temini için aşağıda yer alan Koçtaş Müşteri  
Hattı ve Koçtaş Genel Müdürlük irtibat  
bilgilerinden faydalanınız.

**KOÇTAŞ MÜŞTERİ HİZMETLERİ**

0850 209 50 50