

# TITAN

## Impact Drill 600W

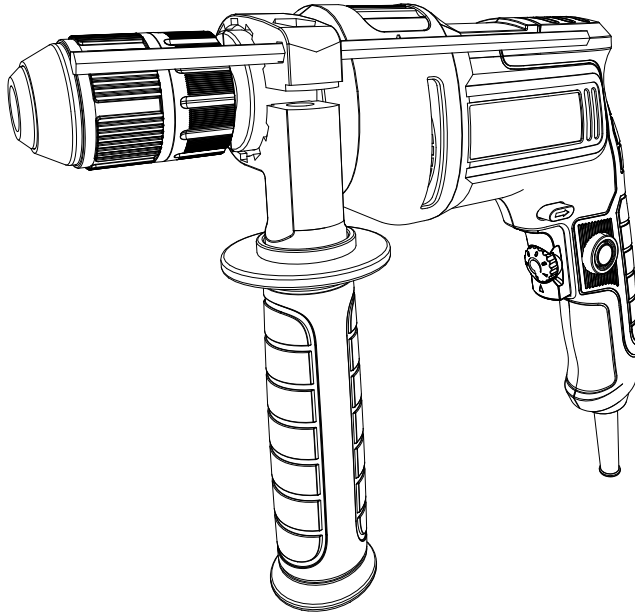

### TTB877DRH

EAN:5059340251905



WARNING: Read the instructions before using the product!

# Let's get started...

These instructions are for your safety. Please read through them thoroughly before use and retain them for future reference.



## Getting **started...** 02

<b>Safety</b> information	03
<b>Your</b> product	15
<b>Before</b> you <b>start</b>	17



## **In more detail...** 20

<b>Product</b> functions	21
<b>Operation</b>	25
<b>Care</b> and <b>maintenance</b>	27
<b>Trouble</b> shooting	30
<b>Recycling</b> and <b>disposal</b>	30
<b>Guarantee</b>	31
<b>EC</b> declaration of <b>conformity</b>	32



## Safety warnings

### General power tool safety warnings



**WARNING!** Read all safety warnings and all instructions. Failure to follow the warnings and instructions may result in electric shock, fire and/or serious injury. Save all warnings and instructions for future reference. The term “power tool” in the warnings refers to your mains-operated (corded) power tool or battery-operated (cordless) power tool.

### Work area safety

- > **Keep work area clean and well lit.** Cluttered or dark areas invite accidents.
- > **Do not operate power tools in explosive atmospheres, such as in the presence of flammable liquids, gases or dust.** Power tools create sparks which may ignite the dust or fumes.
- > **Keep children and bystanders away while operating a power tool.** Distractions can cause you to lose control.

### Electrical safety

- > **Power tool plugs must match the outlet. Never modify the plug in any way. Do not use any adapter plugs with earthed (grounded) power tools.** Unmodified plugs and matching outlets will reduce risk of electric shock.
- > **Avoid body contact with earthed or grounded surfaces, such as pipes, radiators, ranges and refrigerators.** There is an increased risk of electric shock if your body is earthed or grounded.
- > **Do not expose power tools to rain or wet conditions.** Water entering a power tool will increase the risk of electric shock.

## Safety warnings

- > **Do not abuse the cord. Never use the cord for carrying, pulling or unplugging the power tool. Keep cord away from heat, oil, sharp edges or moving parts.** Damaged or entangled cords increase the risk of electric shock.
- > **When operating a power tool outdoors, use an extension cord suitable for outdoor use.** Use of a cord suitable for outdoor use reduces the risk of electric shock.
- > **If operating a power tool in a damp location is unavoidable, use a residual current device (RCD) protected supply.** Use of an RCD reduces the risk of electric shock.

## Personal safety

- > **Stay alert, watch what you are doing and use common sense when operating a power tool. Do not use a power tool while you are tired or under the influence of drugs, alcohol or medication.** A moment of inattention while operating power tools may result in serious personal injury.
- > **Use personal protective equipment. Always wear eye protection.** Protective equipment such as dust mask, non-skid safety shoes, hard hat, or hearing protection used for appropriate conditions will reduce personal injuries.
- > **Prevent unintentional starting. Ensure the switch is in the off-position before connecting to power source and/or battery pack, picking up or carrying the tool.** Carrying power tools with your finger on the switch or energising power tools that have the switch on invites accidents.



- > **Remove any adjusting key or wrench before turning the power tool on.** A wrench or a key left attached to a rotating part of the power tool may result in personal injury.
- > **Do not overreach. Keep proper footing and balance at all times.** This enables better control of the power tool in unexpected situations.
- > **Dress properly. Do not wear loose clothing or jewellery. Keep your hair, clothing and gloves away from moving parts.** Loose clothes, jewellery or long hair can be caught in moving parts.
- > **If devices are provided for the connection of dust extraction and collection facilities, ensure these are connected and properly used.** Use of dust collection can reduce dust-related hazards.

### Power tool use and care

- > **Do not force the power tool. Use the correct power tool for your application.** The correct power tool will do the job better and safer at the rate for which it was designed.
- > **Do not use the power tool if the switch does not turn it on and off.** Any power tool that cannot be controlled with the switch is dangerous and must be repaired.
- > **Disconnect the plug from the power source and/or the battery pack from the power tool before making any adjustments, changing accessories, or storing power tools.** Such preventive safety measures reduce the risk of starting the power tool accidentally.
- > **Store idle power tools out of the reach of children and do not allow persons unfamiliar with the power tool or these instructions to operate the power tool.** Power tools are dangerous in the hands of untrained users.

## Safety warnings

- > **Maintain power tools. Check for misalignment or binding of moving parts, breakage of parts and any other condition that may affect the power tool's operation. If damaged, have the power tool repaired before use.** Many accidents are caused by poorly maintained power tools.
- > **Keep cutting tools sharp and clean.** Properly maintained cutting tools with sharp cutting edges are less likely to bind and are easier to control.
- > **Use the power tool, accessories and tool bits etc. in accordance with these instructions, taking into account the working conditions and the work to be performed.** Use of the power tool for operations different from those intended could result in a hazardous situation.

## Service

- > **Have your power tools serviced by a qualified repair person using only identical replacement parts.** This will ensure that safety of the power tool is maintained.

## Drill safety warnings

- > **Wear ear protectors when impact drilling** Exposure to noise can cause hearing loss.
- > **Use auxiliary handle(s), if supplied with the tool.** Loss of control can cause personal injury.
- > **Hold power tool by insulated gripping surfaces, when performing an operation where the cutting accessory may contact hidden wiring or its own cord.** Cutting accessory contacting a "live" wire may make exposed metal parts of the power tool "live" and could give the operator an electric shock.

## Safety instructions when using long drill bits

- a) Never operate at higher speed than the maximum speed rating of the drill bit. At higher speeds, the bit is

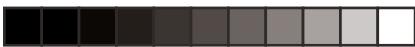

likely to bend if allowed to rotate freely without contacting the workpiece, resulting in personal injury.

b) Always start drilling at low speed and with the bit tip in contact with the workpiece. At higher speeds, the bit is likely to bend if allowed to rotate freely without contacting the workpiece, resulting in personal injury.

c) Apply pressure only in direct line with the bit and do not apply excessive pressure. Bits can bend causing breakage or loss of control, resulting in personal injury.

### **Vibration and noise reduction**

**To reduce the impact of noise and vibration emission, limit the time of operation, use low-vibration and low-noise operating modes as well as wear personal protective equipment.**

Take the following points into account to minimise the vibration and noise exposure risks:

- >Only use the product as intended by its design and these instructions.
- >Ensure that the product is in good condition and well maintained.
- >Use correct attachments for the product and ensure they are in good condition.
- >Keep tight grip on the handles/grip surface.
- >Maintain this product in accordance with these instructions and keep it well lubricated (where appropriate).
- >Plan your work schedule to spread any high vibration tool use across a longer period of time.

### **Emergency**

**Familiarise yourself with the use of this product by means of this instruction manual. Memorise the safety directions and follow them to the letter. This will help to prevent risks and hazards.**

## Safety warnings

- > **Always be alert when using this product, so that you can recognise and handle risks early.** Fast intervention can prevent serious injury and damage to property.
- > **Switch off and disconnect from the power supply if there are malfunctions.** Have the product checked by a qualified professional and repaired, if necessary, before you operate it again.

### Residual risks

**Even if you are operating this product in accordance with all the safety requirements, potential risks of injury and damage remain. The following dangers can arise in connection with the structure and design of this product:**

- > Health defects resulting from vibration emission if the product is being used over long periods of time or not adequately managed and properly maintained.
- > Injuries and damage to property due to broken cutting attachments or the sudden impact of hidden objects during use.
- > Danger of injury and property damage caused by flying objects.



**WARNING!** This product produces an electromagnetic field during operation! This field may under some circumstances interfere with active or passive medical implants! To reduce the risk of serious or fatal injury, we recommend persons with medical implants to consult their doctor and the medical implant manufacturer before operating this product!





The following information applies to professional users only but is good practice for all users:

## **ADDITIONAL SAFETY WARNING FOR CONSTRUCTION DUST**

- > The updated Control of Substances Hazardous to Health Regulations 1st October 2012 now also targets to reduce the risks associated with silica, wood and gypsum dusts.
- > Construction workers are one of the at-risk groups within this because of the dust that they breathe: silica dust is not just a nuisance; it is a real risk to your lungs!
- > Silica is a natural mineral present in large amounts in things like sand, sandstone and granite. It is also commonly found in many construction materials such as concrete and mortar. The silica is broken into very fine dust (also known as Respirable Crystalline Silica or RCS) during many common tasks such as cutting, drilling and grinding Breathing in very fine particles of crystalline silica can lead to the development of:
  - > Lung cancer Silicosis Chronic Obstructive Pulmonary Disorder (Chronic obstructive pulmonary disease (COPD) And breathing in fine particles of wood dust can lead to the development of Asthma The risk of lung disease is linked to people who regularly breathe construction dust over a period of time, not on the odd occasion.
  - > To protect the lung, the COSHH Regulations sets a limit on the amount of these dusts that you can breathe (called a Workplace Exposure Limit or WEL) when averaged over a normal working day.  
These limits are not a large amount of dust: when compared to a penny it is tiny – like a small pinch of salt:

## Safety warnings

This limit is the legal maximum; the most you can breathe after the right controls have been used.

How to reduce the amount of dust?

1. Reduce the amount of cutting by using the best sizes of building products.
2. Use a less powerful tool e.g. a block cutter instead of angle grinder.
3. Using a different method of work altogether – e.g. using a nail gun to direct fasten cable trays instead of drilling holes first.

Please always work with approved safety equipment, such as those dust masks that specially designed to filter out microscopic particles and use the dust extraction facility at all time.

For more information please see the HSE website:

<http://www.hse.gov.uk/construction> or  
<http://www.hse.gov.uk/pubns/cis69.pdf>

**⚠ Warning: Some dust particles created by power sanding, sawing, grinding, drill and other construction jobs contain chemicals known to cause cancer, birth defects or other reproductive harm.** Some examples of these chemicals are:

- Lead from lead-based paints
- Crystalline silica from bricks and cement and other masonry products.
- Arsenic and chromium from chemically treated timber



Your risk from these exposures varies, depending upon how often you do this type of work. To reduce your exposure to these chemicals:

- Work in a well-ventilated area
- Work with approved safety equipment, such as those dust masks that are specially designed to filter microscopic particles.

## VIBRATION

The European Physical Agents (Vibration) Directive has been brought in to help reduce hand arm vibration syndrome injuries to power tool users. The directive requires power tool manufacturers and suppliers to provide indicative vibration test results to enable users to make informed decisions as to the period of time a power tool can be used safely on a daily basis and the choice of tool.

The declared vibration emission value should be used as a minimum level and should be used with the current guidance on vibration.

Calculating the actual period of the actual period off use can be difficult and the HSE website has further information.

The declared vibration emission been measured in accordance with a standardised test stated above and may be used to compare one tool with another tool.

The declared vibration emission value may also be used in a preliminary assessment of exposure.

## Safety warnings

**⚠ Warning:** The vibration emission value during actual use of the power tool can differ from the declared value depending on the ways in which the tool is used dependant on the following examples and other variations on how the tool is used:

How the tool is used and the materials being cut or drilled.

The tool being in good condition and well maintained.

The use the correct accessory for the tool and ensuring it is sharp and in good condition.

The tightness of the grip on the handles.

And the tool is being used as intended by its design and these instructions.

**While working with this power tool, hand/arm vibrations occur. Adopt the correct working practices in order to reduce the exposure to vibration. This tool may cause hand-arm vibration syndrome if its use is not adequately managed.**

**⚠ Warning:** Identify safety measures to protect the operator that are based on an estimation of exposure in the actual conditions of use (taking account of all parts of the operating cycle such as the times when the tool is switched off and when it is running idle in addition to the trigger time). Note The use of other tools will reduce the users' total working period on this tool.

Helping to minimise your vibration exposure risk. ALWAYS use sharp chisels, drills and blades.



Maintain this tool in accordance with these instructions and keep well lubricated (where appropriate).













Avoid using tools in temperatures of 10°C or less. Plan your work schedule to spread any high vibration tool use across a number of days.

### **Health surveillance**

All employees should be part of an employer's health surveillance scheme to help identify any vibration related diseases at an early stage, prevent disease progression and help employees stay in work.

## Symbols

On the product, the rating label and within these instructions you will find among others the following symbols and abbreviations. Familiarize yourself with them to reduce hazards like personal injuries and damage to property.

V~	Volt, (alternating voltage)	mm	Millimetre
Hz	Hertz	kg	Kilogram
W	Watt	dB(A)	Decibel (A-rated)
/min or min <sup>-1</sup>	Per minute	m/s <sup>2</sup>	Metres per seconds squared
	Lock / to tighten or secure.		Unlock / to loosen.
	Note / Remark.		Caution / Warning.
	Read the instruction manual.		Wear hearing protection.
	Wear eye protection.		Wear a dust mask.
	Wear protective gloves.		Wear protective, slip-resistant footwear.
yyWxx	Manufacturing date code; year of manufacturing (20yy) and week of manufacturing (Wxx)		
	Switch the product off and disconnect it from the power supply before assembly, cleaning, adjustments, maintenance, storage and transportation.		
	This product is of protection class II. That means it is equipped with enhanced or double insulation.		
	UK Conformity Assessed		
	The product complies with the applicable European directives and an evaluation method of conformity for these directives was done.		
	WEEE symbol. Waste electrical products should not be disposed of with household waste. Please recycle where facilities exist. Check with your Local Authority or local store for recycling advice.		



## Your product

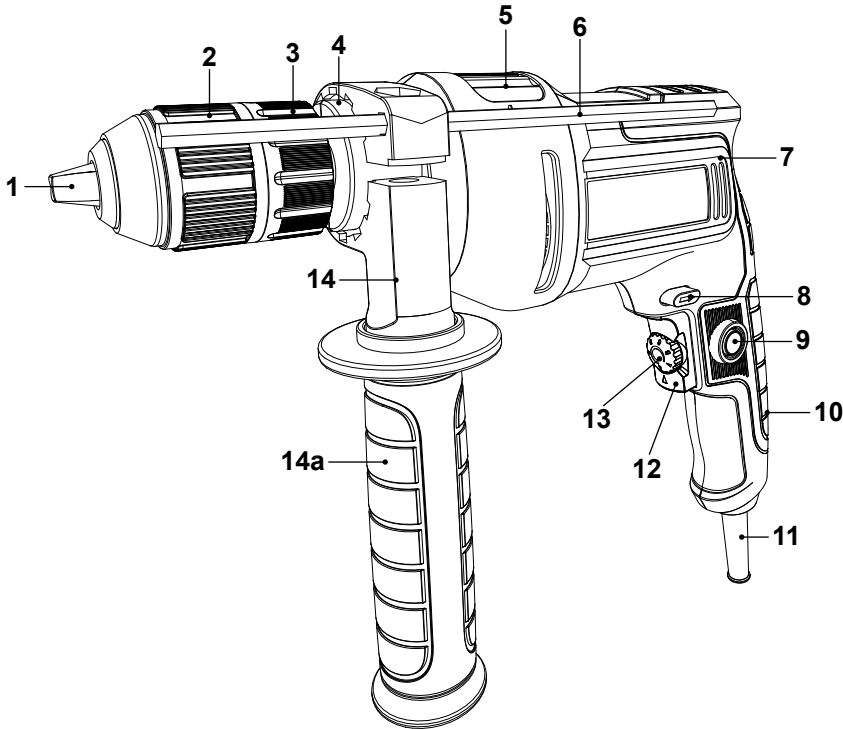

- |                                     |                          |
|-------------------------------------|--------------------------|
| 1. Chuck jaws                       | 9. Lock-on button        |
| 2. Chuck sleeve                     | 10. Main handle          |
| 3. Keyless chuck                    | 11. Power cord with plug |
| 4. Collar                           | 12. On/off switch        |
| 5. Mode selector                    | 13. Speed dial           |
| 6. Depth stop                       | 14. Auxiliary handle     |
| 7. Air vents                        | a. Hand grip             |
| 8. Forward/reverse rotation control |                          |

Getting started...

## Technical specification

### General

> Rated voltage, frequency	: 220 – 240 V~ ,50 Hz
> Rated power input	: 600 W
> Rated no load speed $n_0$	: 0 - 3000 min <sup>-1</sup>
> Impact rate	: 0 - 48000 min <sup>-1</sup>
> Drill chuck capacity	: max. 13 mm
> Protection class	: II 
> Weight	: approx. 2 kg

### Drilling capacity

> into wood	: Ø 25 mm
> into metal	: Ø 13 mm
> into masonry	: Ø 13 mm

### Sound values

> Sound pressure level $L_{pA}$	: 96.3 dB(A)
> Sound power level $L_{WA}$	: 107.3 dB(A)
> Uncertainty $K_{pA}$ , $K_{WA}$	: 3 dB(A)

### Hand arm vibration values

> Drilling into metal $a_{h,D}$	: 1.895 m/s <sup>2</sup>
> Impact drilling into concrete $a_{h, ID}$	: 14.762 m/s <sup>2</sup>
> Uncertainty K	: 1.5 m/s <sup>2</sup>

The sound values have been determined according to noise test code given in EN62841-1, using the basic standards EN ISO 3744 and EN ISO 11203.

The sound intensity level for the operator may exceed 80 dB(A) and ear protection measures are necessary.

The declared vibration value has been measured in accordance with a standard test method (according to EN 62841-2-1) and may be used for comparing one product with another. The declared vibration value may also be used in a preliminary assessment of exposure.



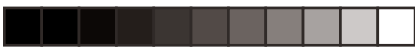

**WARNING!** Depending on the actual use of the product the vibration values can differ from the declared total. Adopt proper measures to protect yourself against vibration exposures. Take the whole work process including times the product is running under no load or switched off into consideration.

Proper measures include among others regular maintenance and care of the product and accessories, keeping hands warm, periodical breaks and proper planning of work processes.

#### RATING LABEL EXPLANATION

TTB877DRH = Model Number

TT = TITAN

B = 220-240V~

877 - Sequential Code

DRH = Impact Drill

## Unpacking

- > Unpack all parts and lay them on a flat, stable surface
- > Remove all packing materials and shipping devices, if applicable.
- > Make sure the delivery contents are complete and free of any damage. If you find that parts are missing or show damage do not use the product but contact your dealer. Using an incomplete or damaged product represents a hazard to people and property.
- > Ensure that you have all the accessories and tools needed for assembly and operation. This also includes suitable personal protective equipment.



**WARNING!** The product and the packaging are not children's toys! Children must not play with plastic bags, sheets and small parts! There is a danger of choking and suffocation!

## You will need

#### (items not supplied)

suitable personal protective equipment  
suitable drill bits  
cooling lubricant (for drilling into metal)

#### (items supplied)

depth stop (6)  
auxiliary handle (14)

## Setup



**WARNING!** The product must be fully assembled before operation! Do not use a product that is only partly assembled or assembled with damaged parts!  
Follow the assembly instructions step-by-step and use the pictures provided as a visual guide to easily assemble the product!  
Do not connect the product to power supply before it is completely assembled!

## Drill bits

Different drill bits can be used with this product depending on the material being worked with.



**WARNING!** Always use drill bits according to the intended use! For example, never use drill bit intended for working on wood for working on metal or vice versa!  
Observe the technical requirements of this product (see section Technical specifications) when purchasing and using drill bits  
Some drill bits are very sharp and become hot during use! Handle them carefully! Wear protective gloves when handling drill bits in order to avoid injuries like burns and cuts!

## Inserting

- > Hold the keyless chuck (3) in position and turn the chuck sleeve (2) anticlockwise until the chuck jaws (1) have opened wide enough to insert the drill bit (Fig. 1). Insert the drill bit all the way to the stop (Fig. 2).
- > Hold the keyless chuck (3) in position and turn the chuck sleeve (2) clockwise until the drill bit is properly fastened in the chuck jaws (1) (Fig. 3).

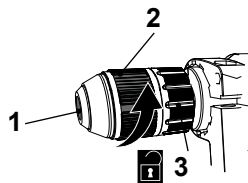

Fig. 1

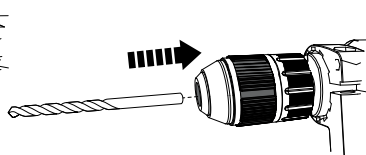

Fig. 2

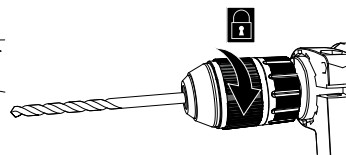

Fig. 3



**WARNING!** After a short operation, switch the product off and check once again that the bit is properly fastened! Caution, the bit could be hot!



## Replacing/Removing

- > Hold the keyless chuck (3) in position and turn the chuck sleeve (2) anticlockwise until the chuck jaws (1) have opened wide enough to remove the bit.
- > Remove the bit and insert a new one as described above if desired.

## Depth stop

- > Insert the depth stop (6) through the hole as indicated. (Fig. 4). Make sure the rippled part is on the bottom side.
- > Align the tip of the depth stop (6) with the drill tip. Now pull the depth stop (6) back by the required drilling depth.
- > Tighten the auxiliary handle (14) to fix the depth stop (6).

**EXAMPLE:** The required drilling depth is 3 cm. Align the tips of the depth stop and drill bit. Read the value indicated on the scale of the depth stop and subtract 3cm. Then adjust the depth stop according to the calculated result.

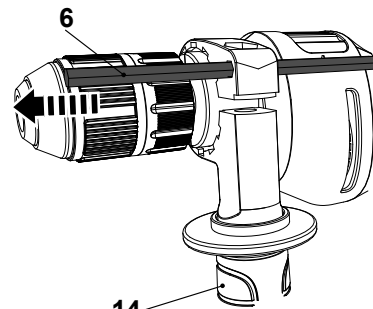

Fig. 4

## Connection to power supply

- > Make sure the on/off switch (12) is in its off position.
- > Connect the plug with a suitable socket.



**WARNING!** Check the voltage! The voltage must comply with the information on the rating label!

- > Your product is now ready to be used.

## In more detail...



<b>Product functions</b>	21
<b>Operation</b>	25
<b>Care and maintenance</b>	27
<b>Trouble shooting</b>	30
<b>Recycling and disposal</b>	30
<b>Guarantee</b>	31
<b>EC declaration of conformity</b>	32

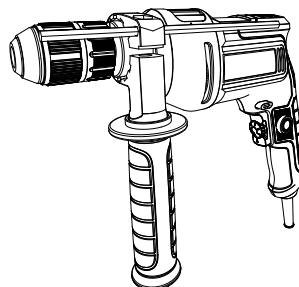

## Intended use

This product is intended for drilling in wood, and similar materials, e.g. MDF, plywood etc, plastic and metal as well as for impact drilling in masonry. It should not be used for screw driving and working on materials that are dangerous to health.

For safety reasons it is essential to read the entire instruction manual before first operation and to observe all the instructions therein.

## Auxiliary handle



**WARNING!** Always switch the product off and disconnect it from power supply before making any adjustments!

Adjust the auxiliary handle (14) according to the desired application. It improves control when using the product.

- > Turn the hand grip (14a) anticlockwise to loosen the clamp.
- > Adjust the auxiliary handle (14) to the desired working position so that you can hold the product safely during operation. Make sure a notch of the auxiliary handle (14) is engaged with the tooth on the collar (4).
- > Turn the hand grip (14a) clockwise to tighten the clamp (Fig. 5).

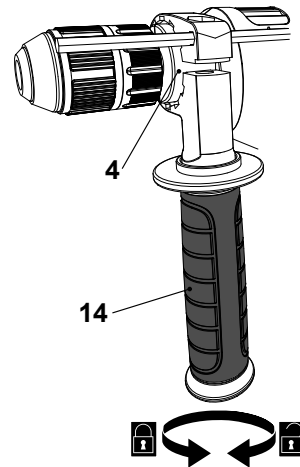

Fig. 5



**WARNING!** Never operate the product without the auxiliary handle to avoid accidents and injury! Always ensure that the auxiliary handle is attached and secured correctly before operation! The auxiliary handle provides better control of the product in case of sudden jams during use when considerable forces are released!

In more detail...

## Mode selector

Select the mode before operation. This product can be operated either in hammer drilling or drilling.



**WARNING!** Only change the mode settings when the product is switched off and has come to a complete stop! Always ensure that the mode selector is adjusted to the correct position depending on the intended operation! Do not use the product with the switch in any intermediate position!

- > Push the mode selector (5) in the desired position.
- > Do not use the product if the mode selector (5) is in any intermediate position.

Function	Mode selection	Symbol indicator	Application
Hammer drilling			hammer and drill action (brick, concrete and masonry)
Drilling			Drill action (wood, metal and plastic)

## Forward / reverse rotation control

Change the rotational direction from forward to reverse by pressing the forward / reverse rotation control (8).



**WARNING!** Only change the rotational direction when the product is switched off and has come to a complete stop! Always ensure that the forward / reverse rotation control is adjusted to the correct position depending on the intended operation!  
Always push the forward / reverse rotation control as far as it will go!  
Do not use the product with the control switch in any other position!

- > Move the forward / reverse rotation control switch (8) to the left (as seen from the operators position) in order to use the product in a clockwise rotational mode (Fig. 6).
- > Move the forward / reverse rotation control switch (8) to the right (as seen from the operators position) in order to use the product in anticlockwise rotational mode (Fig. 7).

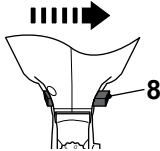
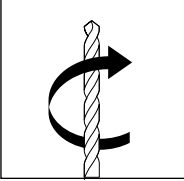
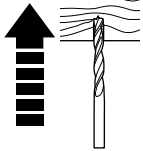
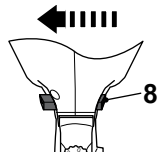
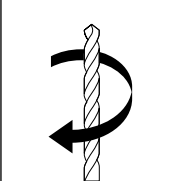
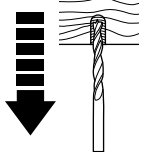
Position	Rotational direction	Application
 Fig. 6		 drilling into material
 Fig. 7		 loosen jammed drill bits



**NOTE:** If you are using the product for the first time after changing the rotational direction, a locking sound may be heard. This is normal and does not represent a defect.

## Switching on/off

Operate the product either in instant or continuous mode.

### Instant mode

- > Switch the product on by pressing the on/off switch (12) (Fig. 8).
- > Switch the product off by releasing the on/off switch (12) (Fig. 8).

In more detail...

## Switching on/off

### Continuous mode

- > Switch the product on by pressing the on/off switch (12) and hold it in position (Fig. 8).
- > Press the lock-on button (9) to lock the on/off switch (12) (Fig. 8).
- > Release both switches. The on/off switch (12) is now locked-on for continuous use.
- > Depress and release the on/off switch (12) to switch the product off.

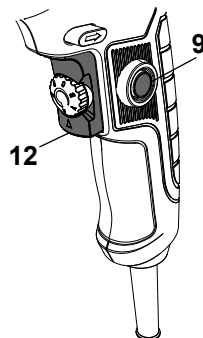

Fig. 8

### Speed control

- > Adjust the speed directly when operating with the built-in speed control. The on/off switch (12) of this product is combined with a speed control. The speed is controlled by how far the trigger switch is depressed.

## Speed dial

- Limit the maximum speed using the speed dial (13). The variable speed device enables you to select the best speed for a particular application (Fig. 9).
- > Turn the speed dial (13) towards "F" to increase the maximum speed.
  - > Turn the speed dial (13) towards "A" to decrease the maximum speed.

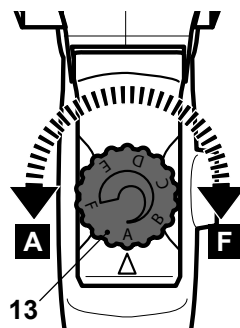

Fig. 9



## General operation

- > Check the product, its power cord and plug as well as accessories for damage before each use. Do not use the product if it is damaged or shows wear.
- > Double check that the accessories and attachments are properly fixed
- > Always hold the product on its handles. Keep the handles dry to ensure safe support.

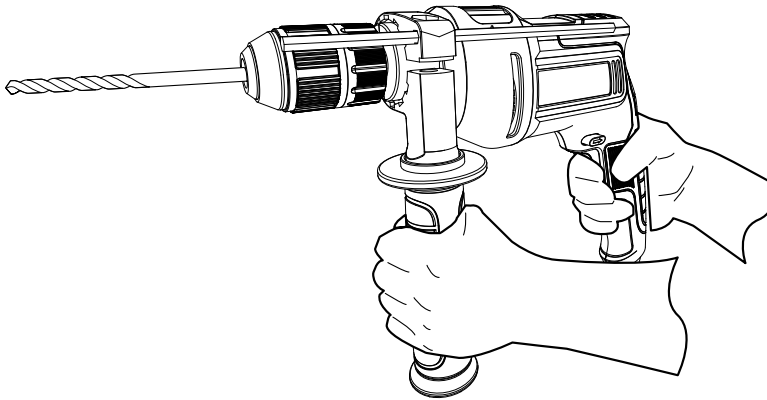

Fig. 10

- > Ensure that the air vents are always unobstructed and clear. Clean them if necessary with a soft brush. Blocked air vents may lead to overheating and damage the product.
- > Switch the product off immediately if you are disturbed while working by other people entering the working area. Always let the product come to complete stop before putting it down.
- > Do not overwork yourself. Take regular breaks to ensure you can concentrate on the work and have full control over the product.



**WARNING!** Keep in mind that there are buried objects hidden in every household! Ensure that there are no gas, water or power lines hidden in the working area that may be hit before operation – danger of electrical shock and serious damage to people and property! Use a suitable detector to trace such objects in advance!

## Drilling

### General drilling



**WARNING!** During operation fine dust will be generated. Some dusts are highly inflammable and explosive! Do not smoke during operation, keep heat sources and open flames out of the working area!



Always wear a dust mask to protect yourself against hazards resulting from fine dust.



- > Always hold the product perpendicular to the point to be drilled. Holding it at an angle may cause slipping or jamming of the drill bit.
- > Always place the drill tip directly on the point to be drilled first and then switch the product on.
- > Pre-drill larger holes with a small diameter drill bit first. Doing so makes drilling with larger diameter drill bits easier.



**WARNING!** Switch the product off, let it come to a complete stop and disconnect it from the power supply if the attachment gets stuck in the workpiece. Only then free the jammed attachment.



### Hammer drilling mode

Use this function to drill holes in masonry.



**NOTE:** In principle, drill masonry in the hammer drilling operation mode. However, in the first few seconds of operation, the drill bit may deviate from the original desired position due to the hammer action. To avoid this, turn the hammer function off and pre-drill the hole in the drilling mode.

- > Set the mode selector to the correct position.
- > Insert a suitable drill bit.



## Drilling mode

Use this function to drill holes into wood, wood similar materials, plastic or metal.

- > Set the mode selector to the correct position.
- > Insert a suitable drill bit. Punch the drilling point before operation in order to avoid slipping of the drill bit.
- > Use a metal drill bit for drilling into plastic and metal. Where necessary use a cooling lubricant that is available at your specialist dealer.

## After use

- > Switch the product off, disconnect it from the power supply and let it cool down.
- > Check, clean and store the product as described below.

## The golden rules for care



**WARNING!** Always switch the product off, disconnect the product from the power supply and let the product cool down before performing inspection, maintenance and cleaning work!



- > Keep the product clean. Remove debris from it after each use and before storage.
- > Regular and proper cleaning will help ensure safe use and prolong the life of the product.
- > Inspect the product before each use for worn and damaged parts. Do not operate it if you find broken and worn parts



**WARNING!** Only perform repairs and maintenance work according to these instructions! All further works must be performed by a qualified specialist!

## General cleaning

- > Clean the product with a dry cloth. Use a brush for areas that are hard to reach.
- > In particular clean the air vents (7) after every use with a cloth and brush.
- > Remove stubborn dirt with high pressure air (max. 3 bar).



**NOTE:** Do not use chemical, alkaline, abrasive or other aggressive detergents or disinfectants to clean this product as they might be harmful to its surfaces.

## General cleaning

> Check for worn or damaged parts. Replace worn parts as necessary or contact an authorised service centre for repair before using the product again.

## Maintenance

Before and after each use, check the product and accessories (or attachments) for wear and damage. If required, exchange them for new ones as described in this instruction manual. Observe the technical requirements.

## Power cord

If the supply cord of this power tool is damaged, it must be replaced by a specially prepared cord available through the service organization.

## UK plug

If you need to replace the fitted plug, then follow the instructions below. **IMPORTANT:** The wires in the mains lead are coloured in accordance with the following code:

Blue – Neutral Brown – Live

As the colours of the wire in the mains lead of this product may not correspond with the coloured marking identifying the terminals in your plug, proceed as follows. The wire, which is coloured blue, must be connected to the terminal, which is marked with N or coloured black. The wire, which is coloured brown, must be connected to the terminal, which is marked L or coloured red.

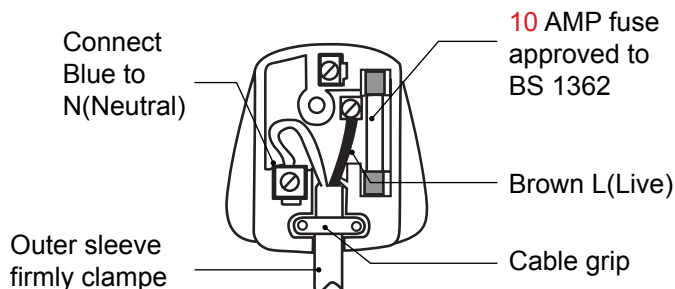



**WARNING!** Never connect live or neutral wires to the earth terminal of the plug, which is marked with E.

Only fit an approved 13 Amp BS 1363 or BS 1363/A plug and the correctly rated fuse. If in doubt, consult a qualified electrician



**NOTE:** If a moulded plug is fitted and has to be removed take great care in disposing of the plug and severed cable, it must be destroyed to prevent engaging into a socket.

## Repair

---

This product does not contain any parts that can be repaired by the consumer. Contact an authorised service centre or a similarly qualified person to have it checked and repaired.

## Storage

---

- > Switch the product off and disconnect it from the power supply.
- > Clean the product as described above.
- > Store the product and its accessories in a dark, dry, frost-free, well-ventilated place.
- > Always store the product in a place that is inaccessible to children. The ideal storage temperature is between 10°C and 30°C.
- > We recommend using the original package for storage or covering the product with a suitable cloth or enclosure to protect it against dust.

## Transportation

---

- > Switch the product off and disconnect it from the power supply.
- > Attach transportation guards, if applicable.
- > Always carry the product by its main handle (10).
- > Protect the product from any heavy impact or strong vibrations which may occur during transportation in vehicles.
- > Secure the product to prevent it from slipping or falling over.

## Troubleshooting

Suspected malfunctions are often due to causes that the users can fix themselves. Therefore check the product using this section. In most cases the problem can be solved quickly.



**WARNING!** Only perform the steps described within these instructions! All further inspection, maintenance and repair work must be performed by an authorised service centre or a similarly qualified specialist if you cannot solve the problem yourself!

Problem	Possible cause	Solution
1. Product does not start	1.1 Not connected to power supply 1.2 Power cord or plug is defective 1.3 Other electrical defect to the product	1.1 Connect to power supply 1.2 Check by a specialist electrician 1.3 Check by a specialist electrician
2. Product does not reach full power	2.1 Extension cord not suitable for operation with this product 2.2 Power source (e.g. generator) has too low voltage 2.3 Air vents are blocked	2.1 Use a proper extension cord 2.2 Connect to another power source 2.3 Clean the air vents
3. Unsatisfactory result	3.1 Drill bit is dull/damaged 3.2. Drill bit not suitable for work piece material	3.1 Replace with new one 3.2 Use proper drill bit
4. Excessive vibration or noise	4.1 Drill bit is dull/damaged 4.2 Bolts/nuts are loose	4.1 Replace with a new one 4.2 Tighten bolts/nuts

## Recycling and disposal



Waste electrical products should not be disposed of with household waste. Please recycle where facilities exist. Check with your Local Authority or local store for recycling advice.



## Guarantee

We take special care to select high quality materials and use manufacturing techniques that allow us to create products incorporating design and durability. This product (TITAN 600W Impact Drill) has a manufacturer's guarantee of 2 years against manufacturing defects, from the date of purchase (if bought in store) or date of delivery (if bought online), at no additional cost for normal (non-professional or commercial) household use.

To make a claim under this guarantee, you must present your proof of purchase (such as a sales receipt, purchase invoice or other evidence admissible under applicable law), please keep your proof of purchase in a safe place. For this guarantee to apply, the product you purchased must be new, it will not apply to second hand or display products. Unless stated otherwise by applicable law, any replacement product issued under this guarantee will only be guaranteed until expiry of the original guarantee period.

This guarantee covers product failures and malfunctions provided the product was used for the purpose for which it is intended and subject to installation, cleaning, care and maintenance in accordance with the information contained in these terms and conditions, in the user manual and standard practice, provided that standard practice does not conflict with the user manual.

This guarantee does not cover defects and damage caused by normal wear and tear or damage that could be the result of improper use, faulty installation or assembly, neglect, accident, misuse, or modification of the product. Unless stated otherwise by applicable law, this guarantee will not cover, in any case, ancillary costs (shipping, movement, costs of uninstalling and reinstalling, labour etc), or direct and indirect damage.

This guarantee does not cover defects and damage caused by or resulting from:

Normal wear and tear

Overload, misuse or neglect

Repairs attempted by anyone other than an authorised agent

Cosmetic damage

Damage caused by foreign objects, substances or accidents

Accidental damage or modification

Failure to follow manufacturer's guidelines

Loss of use of the goods

If the product is defective, we will, within a reasonable time, repair or replace it.

Rights under this guarantee are enforceable in the country in which you purchased this product. Guarantee related queries should be addressed to the store you purchased this product from.

The guarantee is in addition to and does not affect your statutory rights.

## EC declaration of conformity



(EN) EU DECLARATION OF CONFORMITY  
 (FR) DÉCLARATION UE DE CONFORMITÉ  
 (PL) DEKLARACJA ZGODNOŚCI UE  
 (RO) DECLARAȚIA DE CONFORMITATE UE  
 (ES) DECLARACIÓN UE DE CONFORMIDAD  
 (PT) DECLARAÇÃO DE CONFORMIDADE UE

Product/ Produit/ Produkt/Produsul/Producto/Produto

- 600W Impact Drill/Perceuse à percussion/Wiertarka udarowa/Mașină de găurit cu percuție/  
Taladradora de percusión/Berbequim de percussão
- TTB877DRH
- Serial number: from 000001 to 999999

Name and address of the manufacturer or his authorised representative:

Nom et adresse du fabricant ou de son mandataire:

Nazwa i adres producenta lub jego upoważnionego przedstawiciela:

Denumirea și adresa producătorului sau a reprezentantului său autorizat:

Nombre y dirección del fabricante o de su representante autorizado:

Nome e endereço do fabricante ou do respetivo mandatário:

Kingfisher International Products B.V.,  
 Rapenburgerstraat 175E,  
 1011 VM Amsterdam,  
 The Netherlands

This declaration of conformity is issued under the sole responsibility of the manufacturer.  
 La présente déclaration de conformité est établie sous la seule responsabilité du fabricant.  
 Niniejsza deklaracja zgodności wydana zostaje na wyłączną odpowiedzialność producenta.  
 Prezenta declarație de conformitate este emisă pe răspunderea exclusivă a producătorului.  
 La presente declaración de conformidad se expide bajo la exclusiva responsabilidad del fabricante.  
 A presente declaração de conformidade é emitida sob a exclusiva responsabilidade do fabricante.

Object of the declaration/Objet de la déclaration/Przedmiot deklaracji/Obiectul declarației/Objeto de la declaración/Objeto da declaração

Product/Produit/Produkt/Produsul/Producto/Produto	Model/Modèle/Model/Modelul/Modelo/Modelo	EAN
600W Impact Drill/Perceuse à percussion/ Wiertarka udarowa/Mașină de găurit cu percuție/ Taladradora de percusión/Berbequim de percussão	TTB877DRH	5059340251905 5059340251912

The object of the declaration described above is in conformity with the relevant Union harmonisation legislation:

L'objet de la déclaration décrit ci-dessus est conforme à la législation d'harmonisation de l'Union applicable:

Wymieniony powyżej przedmiot niniejszej deklaracji jest zgodny z odpowiednimi wymaganiami unijnego prawodawstwa harmonizacyjnego:

Obiectul declarației descris mai sus este în conformitate cu legislația relevantă de armonizare a Uniunii:

El objeto de la declaración descrita anteriormente es conforme con la legislación de armonización pertinente de la Unión:

O objeto da declaração acima descrito está em conformidade com a legislação de harmonização da União aplicável:

2006/42/EC as amended	Machinery Directive
2014/30/EU as amended	Directive Electromagnetic compatibility
2011/65/EU as amended	Directive Restriction of the use of certain hazardous substances in electrical and electronic equipment



Directive 2006/42/CE relative aux machines  
 2014/30/UE telle que modifiée Directive Compatibilité électromagnétique  
 Directive 2011/65/UE relative à la limitation de l'utilisation de certaines substances dangereuses dans les équipements électriques et électroniques  
 2006/42/WE w zmienionej dyrektywie maszynowej  
 2014/30/UE ze zmianami Dyrektywa Kompatybilność elektromagnetyczna  
 2011/65/UE ze zmianami Dyrektywa Ograniczenie stosowania niektórych niebezpiecznych substancji w sprzęcie elektrycznym i elektronicznym  
 2006/42/CE, astfel a fost modificată Directiva privind echipamentele  
 2014/30/UE, astfel a fost modificată Directiva privind compatibilitatea electromagnetică  
 2011/65/UE, astfel a fost modificată Directiva privind limitarea utilizării anumitor substanțe periculoase în echipamentele electrice și electronice  
 Directiva sobre maquinaria modificada 2006/42/CE  
 2014/30/UE modificada Directiva Compatibilidad electromagnética  
 2011/65/UE modificada Directiva Restricción del uso de determinadas sustancias peligrosas en equipos eléctricos y electrónicos  
 2006/42/CE como diretiva de máquinas alteradas  
 2014/30/UE como alteração da compatibilidade eletromagnética  
 2011/65/UE como restrição diretiva alterada da utilização de certas substâncias perigosas em equipamentos elétricos e eletrônicos

References to the relevant harmonised standards used or references to the other technical specifications in relation to which conformity is declared:  
 Références des normes harmonisées pertinentes appliquées, y compris la date de celles-ci, ou des autres caractéristiques techniques, y compris la date de celles-ci, par rapport auxquelles la conformité est déclarée:

Odwolania do odnośnych norm zharmonizowanych, które zastosowano, wraz z datą normy, lub do innych specyfikacji technicznych, wraz z datą specyfikacji, w odniesieniu do których deklarowana jest zgodność:

Trimiteri la standardele armonizate relevante folosite, inclusiv data standardului, sau trimiteri la celelalte specificații tehnice, inclusiv data specificațiilor, în legătură cu care se declară conformitatea:  
 Referencias a las normas armonizadas pertinentes utilizadas, incluidas las fechas de las normas, o referencias a las otras especificaciones técnicas, incluidas las fechas de las especificaciones, respecto a las cuales se declara la conformidad:

Referências às normas harmonizadas aplicáveis utilizadas, incluindo a data da norma, ou às outras especificações técnicas, incluindo a data da especificação, em relação às quais é declarada a conformidade:

EN 62841-1:2015  
 EN 62841-2-1:2018+A11:2019  
 EN 55014-1:2017+A11:2020  
 EN 55014-2:2015  
 EN IEC 61000-3-2:2019  
 EN 61000-3-3:2013+A1:2019

Authorized Signatory and technical file holder/ Signataire et responsable de la documentation technique autorisé/ Podmiot uprawniony do wystawienia i adres przechowywania dokumentacji technicznej/ Semnatar autorizat și deținătorul dosarului tehnic/ Firmante autorizado y titular del expediente técnico/Signatário autorizado e detentor da ficha técnica:

Kingfisher International Products B.V.,  
 Rapenburgerstraat 175E,  
 1011 VM Amsterdam,  
 The Netherlands



David Awe  
 Group Quality Director

On: 10/12/2021

In more detail...

## EC declaration of conformity

**UK  
CA**

(UK) DECLARATION OF CONFORMITY

Product

- 600W Impact Drill
- TTB877DRH
- Serial number: from 000001 to 999999

Name and address of the manufacturer or his authorised representative:

Kingfisher International Products Limited  
3 Sheldon Square  
London W2 6PX  
United Kingdom

This declaration of conformity is issued under the sole responsibility of the manufacturer.

Object of the declaration

Product	Model	EAN
600W Impact Drill	TTB877DRH	5059340251905

The object of the declaration described above is in conformity with the relevant legislation:

Supply of Machinery (Safety) Regulations 2008 as amended  
Electromagnetic Compatibility Regulations 2016 as amended  
The Restriction of the use of Certain Hazardous Substances in Electrical and Electronic Equipment Regulations 2012 as amended

References to the relevant designated standards used or references to the other technical specifications in relation to which conformity is declared:

BS EN 62841-1:2015  
BS EN 62841-2-1:2018+A11:2019  
BS EN 55014-1:2017+A11:2020  
BS EN 55014-2:2015  
BS EN IEC 61000-3-2:2019  
BS EN 61000-3-3:2013+A1:2019

Authorized Signatory and technical file holder:  
Kingfisher International Products Limited  
3 Sheldon Square  
London W2 6PX  
United Kingdom

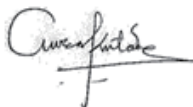

David Awe  
Group Quality Director

On 10/12/2021

In more detail...





# TITAN

Manufacturer, Fabricant, Producent, Producător, Fabricante:

**UK Manufacturer:**

Kingfisher International Products Limited  
3 Sheldon Square, London, W2 6PX  
United Kingdom  
[www.kingfisher.com/products](http://www.kingfisher.com/products)

**EU Manufacturer:**

Kingfisher International Products B.V.  
Rapenburgerstraat 175E  
1011 VM Amsterdam  
The Netherlands  
[www.kingfisher.com/products](http://www.kingfisher.com/products)

- |           |  |   |
|-----------|--|---|
| <b>EN</b> | <a href="http://www.screwfix.com">www.screwfix.com</a><br><a href="http://www.screwfix.ie">www.screwfix.ie</a> | To view instruction manuals online, visit<br><a href="http://www.kingfisher.com/products">www.kingfisher.com/products</a>                                   |
| <b>FR</b> | <a href="http://www.bricodepot.fr">www.bricodepot.fr</a>   | Pour consulter les manuels d'instructions en ligne,<br>rendez-vous sur le site <a href="http://www.kingfisher.com/products">www.kingfisher.com/products</a> |
| <b>ES</b> | <a href="http://www.bricodepot.es">www.bricodepot.es</a>   | Para consultar los manuales de instrucciones en línea,<br>visite <a href="http://www.kingfisher.com/products">www.kingfisher.com/products</a>               |
| <b>PT</b> | <a href="http://www.bricodepot.pt">www.bricodepot.pt</a>   | Para consultar manuais de instruções online, visite<br><a href="http://www.kingfisher.com/products">www.kingfisher.com/products</a>                         |